

EWCM 400D PRO A-STD

Digital scroll series compressor rack controllers

User Manual

9MA10295.02

03/2024

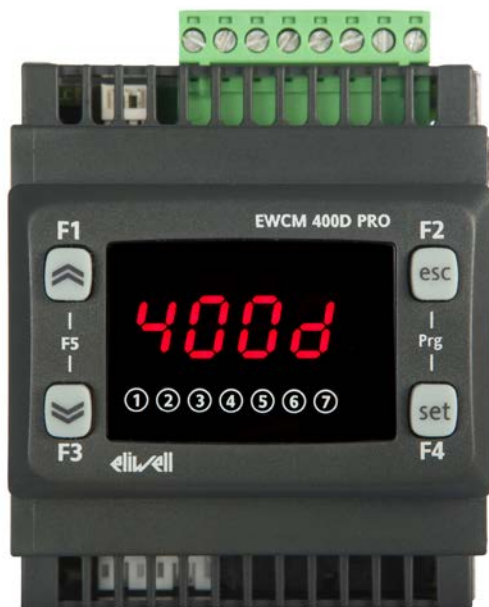

Legal Information

The Schneider Electric brand and any trademarks of Schneider Electric SE and its subsidiaries referred to in this guide are the property of Schneider Electric SE or its subsidiaries. All other brands may be trademarks of their respective owners.

This guide and its content are protected under applicable copyright laws and furnished for informational use only. No part of this guide may be reproduced or transmitted in any form or by any means (electronic, mechanical, photocopying, recording, or otherwise), for any purpose, without the prior written permission of Schneider Electric.

Schneider Electric does not grant any right or license for commercial use of the guide or its content, except for a non-exclusive and personal license to consult it on an “as is” basis. Schneider Electric products and equipment should be installed, operated, serviced, and maintained only by qualified personnel.

As standards, specifications, and designs change from time to time, information contained in this guide may be subject to change without notice.

To the extent permitted by applicable law, no responsibility or liability is assumed by Schneider Electric and its subsidiaries for any errors or omissions in the informational content of this material or consequences arising out of or resulting from the use of the information contained herein.

As part of a group of responsible, inclusive companies, we are updating our communications that contain non-inclusive terminology. Until we complete this process, however, our content may still contain standardized industry terms that may be deemed inappropriate by our customers.

© 2023 Eliwell. All rights reserved.

CONTENTS



CHAPTER	1. Introduction	12
	1.1. Description	12
	1.1.1. Main functions	12
CHAPTER	2. Mechanical installation.....	13
	2.1. Before starting.....	13
	2.2. Disconnection from the power supply	13
	2.3. Operating environment.....	14
	2.4. Comments concerning installation	14
	2.5. SKP 10 installation	15
	2.6. EWCM 400D PRO A-STD installation.....	16
CHAPTER	3. Electrical connections.....	19
	3.1. Best wiring practices	19
	3.1.1. Wiring guidelines	19
	3.1.2. Rules for screw-type terminal boards.....	20
	3.1.3. Protecting the outputs from damage from inductive loads	21
	3.1.4. Specific considerations for handling.....	23
	3.1.5. Analog inputs-probes.....	23
	3.1.6. Serial connections	24
	3.2. Electric diagrams.....	25
	3.2.1. EWCM 436D PRO STD	25
	3.2.2. EWCM 455D PRO STD / EXP 455D PRO / 455P PRO STD.....	27
	3.2.3. Example of low voltage/low current input/output connection.....	28
	3.3. Example of SKP 10 connection.....	31
	3.3.1. SKP 10	31
CHAPTER	4. Technical data	32
	4.1. General Specifications	33
	4.1.1. Technical data	33
	4.2. I/O features	34
	4.2.1. EWCM 436D PRO STD	34
	4.2.2. EWCM 455D PRO / EWCM 455P / EXP 455D PRO STD	35

	4.3. Serial ports	36
	4.3.1. Power supply.....	36
	4.4. Mechanical technical specifications	37
	4.5. Mechanical dimensions.....	38
CHAPTER	5. User Interface (folder PAR/UI).....	39
	5.1. Keys	39
	5.2. LEDs and Display.....	40
	5.2.1. Display.....	40
	5.2.2. LEDs.....	40
	5.3. startup	41
	5.4. Access to folders - Menu structure.....	41
	5.5. BIOS menu.....	41
	5.5.1. BIOS “Status” menu	41
	5.5.2. BIOS programming menu	45
	5.5.3. Functions (Par/FnC folder).....	46
	5.6. 400D STD Application menu	47
	5.6.1. 400D STD Status menu	47
	5.6.2. 400D STD Programming menu	49
CHAPTER	6. Physical I/O configuration (PAR/CL..CE folder)	50
	6.1. CONTROLLER analog inputs	50
	6.2. EXPANSION analog inputs	51
	6.3. Digital inputs.....	51
	6.4. Digital outputs	51
	6.5. Analog outputs	52
CHAPTER	7. Device configuration (PAR/CnF...LEd folder)	53
	7.1. Device configuration parameters	53
	7.1.1. Type of refrigerant	53
	7.1.2. Compressor type and number of steps	54
	7.1.3. Managing the digital and analog fans.....	54
	7.1.4. Temperature probe enabling	54
	7.2. I/O configuration parameters.....	55
	7.2.1. Configuration of analog inputs.....	55
	7.2.2. Configuration of analog outputs	55
	7.2.3. Configuration of digital inputs	56

	7.2.4. Digital output configuration	56
	7.2.5. LED configuration	56
CHAPTER	8. Compressors	57
	8.1. Type of compressors supported	57
	8.1.1. SYSTEM CONFIGURATIONS SUPPORTED	57
	8.1.2. Compressor partialization management	58
	8.2. Compressor regulation	59
	8.2.1. Proportional band regulation	59
	8.2.2. Regulation in neutral area without modulating compressor	61
	8.2.3. Regulation in neutral area with modulating compressor	62
CHAPTER	9. Fans (FAn)	63
	9.1. System configurations supported	63
	9.1.1. Digital fans	63
	9.1.2. Analog fan	64
	9.2. Floating condensation	65
	9.2.1. Functioning conditions	65
	9.2.2. Sub-cooling	66
CHAPTER	10. General Regulator	67
	10.1. Digital output general regulator	67
	10.2. Analog output general regulator	68
CHAPTER	11. Parameters (PAR)	69
	11.1. Parameters / visibility table, folder visibility table and client table	69
	11.1.1. BIOS / visibility parameters table	71
	11.1.2. Folder visibility table	75
	11.1.3. Application parameters table	76
	11.1.4. Client Table	89
CHAPTER	12. Alarms	92
CHAPTER	13. Updating the device	94
	13.1. Direct connection with Device Manager	94
	13.2. Connecting to UNICARD / MFK	95
	13.3. Firmware updating	95
CHAPTER	14. Monitoring	96

14.1. Configuration with Modbus RTU	96
14.1.1. Data format (RTU).....	96
14.1.2. Modbus commands available and data areas.....	97
14.2. device address	97
14.2.1. List of parameter addresses.....	97
14.2.2. List of variable addresses / states	97

SAFETY INFORMATION



Important information

Read these instructions carefully and visually inspect the equipment to familiarize yourself with the device before attempting to install it, put it into operation or service it. The following warning messages may appear anywhere in this documentation or on the equipment to warn of potential dangers or to call attention to information that can clarify or simplify a procedure.



The addition of this symbol to a 'Danger' or 'Warning' safety label indicates that an electrical hazard exists which will result in personal injury if the instructions are not followed.



This is the safety warning symbol. It is used to warn the user of the potential dangers of personal injury. Observe all the safety warnings that follow this symbol to avoid the risk of serious injury or death.

DANGER

DANGER indicates a dangerous situation which, if not avoided, **will result** in death or serious injury.

WARNING

WARNING indicates a dangerous situation which, if not avoided, **could result** in death or serious injury.

CAUTION

CAUTION indicates a potentially dangerous situation which, if not avoided, **could result** in minor or moderate injury.

NOTICE

NOTICE used in reference to procedures not associated with physical injuries.

PLEASE NOTE

Electrical equipment should be installed, operated, serviced, and maintained only by qualified personnel. No responsibility is assumed by Schneider Electric and Eliwell for any consequences arising out of the use of this material. An authorized person is someone in possession of the skills and knowledge applicable to the structure, to the operation of the electrical equipment and to its installation, and who has received safety training in order to recognize and avoid the risks involved.

Personnel qualification

Only personnel with suitable training and an in-depth knowledge and understanding of the contents of this manual and any other documentation relevant to the product are authorized to work on and with this product. Qualified personnel must be capable of identifying any dangers which may arise from the parameterization or changing of parameter values, and from the use of mechanical, electric and electronic equipment in general. Plus, they must be familiar with the personal safety laws, provisions and regulations which must be observed during system planning and implementation.

Permitted use

This product is intended for controlling digital scroll compressor racks.

The device must be installed and used in accordance with the provided instructions and in particular, in normal conditions, dangerous energized parts must not be accessible.

The device must be suitably protected against water and dust based on its application and must also be accessible only with the use of a tool (with the exception of the front panel).

The device is also suitable for integration with equipment for domestic and commercial use and/or similar for refrigeration purposes and has been checked in relation to aspects regarding safety on the basis of the harmonized European standards of reference.

Prohibited use

Any use other than that indicated in the above paragraph "Permitted use" is strictly prohibited.

The relay contacts supplied are electromechanical and are subject to wear. The protective devices specified by international or local standards, must be installed outside the instrument.

Liability and residual risks

The liability of Schneider Electric and Eliwell is limited to the correct and professional use of the product according to the directives referred to herein and in the other supporting documents, and does not cover any damage (including but not limited to) the following causes:

- unspecified installation/use and, in particular, in contravention of the safety requirements of the legislation in force in the country of installation and/or specified in this document;
- use on equipment which does not provide adequate protection against electrocution, water and dust in the actual installation conditions;
- use on devices which allow access to dangerous parts without the aid of a keyed or tooled locking mechanism;
- product tampering and/or alteration;
- installation/use on equipment that does not comply with the regulations in force in the country of installation.

Disposal



The equipment (or product) must be subjected to separate waste collection in compliance with local legislation regarding waste disposal.

INFORMATION ABOUT...



Purpose of the document

This document describes the **EWCM 400D PRO A-STD** controllers and the corresponding accessories, including information regarding installation and wiring.

NOTE: Read this document and all related documents carefully before installing, operating or servicing the controller.

Note regarding validity

This document is valid for **EWCM 400D PRO A-STD** msk 704.

The technical characteristics of the devices described in this manual are also available online, through the Eliwell website. The characteristics illustrated in this manual should be identical to those which can be found online. In accordance with our policy of continuous improvement, the content of the documentation may be revised from time to time in order to improve its clarity and accuracy. If there are any differences between the manual and the online information, the online information takes priority.

Related documents

Document title	Reference document code
User manual EWCM 400D PRO /A STD	9MA10295 (IT) 9MA10295 (EN) 9MA50295 (DE) 9MAA0295 (RU)
Instruction sheet EWCM 400D PRO /A STD	9IS54502

You can download these technical publications and other technical information from our website at:

www.eliwell.com

Product related information

DANGER

HAZARD OF ELECTRIC SHOCK, EXPLOSION OR ARC FLASH

- Disconnect all power from all equipment including connected devices prior to removing any covers or doors, or installing or removing any accessories, hardware, cables or wires except under the specific conditions specified in this hardware guide.
- Always use a properly rated voltage sensing device to confirm the power is off where and when indicated.
- Before restoring the power supply, replace and secure all covers, hardware components and cables.
- For all the devices requiring it, make sure there is an effective ground connection.
- Use only the specified voltage when operating this device and any associated products.

Failure to follow these instructions will result in death or serious injury.

This equipment is designed to operate in non-hazardous locations and where applications which generate (or could potentially generate) hazardous environments have been isolated. Install this equipment only in areas and with applications known to be constantly free from hazardous atmospheres.

DANGER

POTENTIAL FOR EXPLOSION

- Install and use this equipment in non-hazardous locations only.
- Do not install or use this equipment in applications which could generate hazardous atmospheres, such as applications which use flammable refrigerants.

Failure to follow these instructions will result in death or serious injury.

For information regarding the use of control equipment in applications capable of generating hazardous materials, please contact the relevant national regulatory bodies or certifying authorities.

DANGER

HAZARD OF ELECTRIC SHOCK AND FIRE

- Do not expose the equipment to liquids.
- Do not exceed the temperature and humidity ranges defined in the technical specification.

Failure to follow these instructions will result in death or serious injury.

DANGER

HAZARD OF OVERHEATING AND/OR FIRE

- Do not use with loads other than those indicated in the technical specification.
- Do not exceed the maximum permitted current; for higher loads, use a meter with sufficient power capacity.

Failure to follow these instructions will result in death or serious injury.

⚠ WARNING

LOSS OF CONTROL

- The control system designer must consider the potential failure modes of the control circuit and, for some critical control functions, provide a means for reaching a safe condition during and after a circuit failure. Examples of critical control functions are the emergency stop and end of travel stop, power supply cut-off and restart.
- Separate or redundant control circuits must be provided for critical control functions.
- The system control circuits can include communication connections. Keep in mind the implications of transmission delays or sudden connection failures.
- Comply with all standards regarding accident prevention and local applicable safety directives.⁽¹⁾
- Every implementation of this equipment must be tested individually and completely in order to check its proper operation before it is commissioned.

Failure to follow these instructions can result in death, serious injury, or equipment damage.

(1) For additional information, refer to the standards NEMA ICS 1.1 (latest edition), "Safety Guidelines for the Application, Installation, and Maintenance of Solid State Control" and NEMA ICS 7.1 (latest edition) "Safety Standards for Construction and Guide for Selection, Installation and Operation of Adjustable-Speed Drive Systems" or to equivalent standards that regulate your particular location.

⚠ WARNING

UNINTENDED EQUIPMENT OPERATION

- Only use Eliwell-approved software in conjunction with this equipment.
- Update your application program every time you change the physical configuration of the hardware.

Failure to follow these instructions can result in death, serious injury, or equipment damage.

CHAPTER 1

Introduction

1.1. DESCRIPTION

The **EWCM 400D PRO A-STD** controller is a compact solution in the context of the **Eliwell** parametric controller platform, designed to manage digital scroll (DGS) compressor racks.

NOTE: The photos in this manual are purely indicative, to illustrate the **EWCM 400D PRO A-STD** product.
The dimensions shown in the figures are not to scale.

The **EWCM 400D PRO A-STD** range includes:

- **Controller with built-in display;**
- **Remote display;**
- **I/O expansion;**

1.1.1. Main functions

- Suction pressure control via an Inverter or Digital Scroll compressor and up to max. 4 single compressors;
- Discharge pressure control via digital fans or analog output for inverter control;
- Floating condensation;
- Full diagnostics;
- Parameter settings via keyboard or PC;
- **MFK / UNICARD** to upload and download parameter maps;
- Analog inputs which can be configured via NTC parameters, 0...20 mA, 4...20 mA, 0...1 V, 0...5 V, 0...10 V or digital inputs;
- RS-485 serial and Modbus RTU supervision protocol;
- Optional remote display (cable up to 10 m - 32.8 ft) which may be connected up directly without a serial interface.

CHAPTER 2

Mechanical installation

2.1. BEFORE STARTING

Before starting to install the system, read this chapter carefully. Take particular care to comply with all information relating to safety, various electrical requirements and legal regulation which could apply to your machine or your process if using this equipment. The use and application of the information contained in this document require experience in the design and programming of automated control systems. Only the user, machine manufacturer or integrator can be familiar with all the process conditions and can therefore establish which automation and associated equipment and related safety devices and interlocks can be used efficiently and correctly. When choosing the automation and control equipment - and any other related equipment or software - for a particular application, you must also take account of all applicable local, regional or national standards and/or regulations.

WARNING

REGULATORY INCOMPATIBILITY

Make sure that all equipment used and systems designed comply with all applicable local, regional and national laws.

Failure to follow these instructions can result in death, serious injury, or equipment damage.

2.2. DISCONNECTION FROM THE POWER SUPPLY

All optional elements and modules must be assembled and installed before installing the control system on an assembly rail, panel door or other assembly surface. Before dismantling the equipment, remove the control systems from the assembly rail, plate or panel.

DANGER

HAZARD OF ELECTRIC SHOCK, EXPLOSION OR ARC FLASH

- Disconnect all power from all equipment including connected devices prior to removing any covers or doors, or installing or removing any accessories, hardware, cables or wires except under the specific conditions specified in this hardware guide.
- Always use a properly rated voltage sensing device to confirm the power is off where and when indicated.
- Before restoring the power supply, replace and secure all covers, hardware components and cables.
- For all the devices requiring it, make sure there is an effective ground connection.
- Use only the specified voltage when operating this device and any associated products.

Failure to follow these instructions will result in death or serious injury.

2.3. OPERATING ENVIRONMENT

This equipment is designed to operate in non-hazardous locations and where applications which generate (or could potentially generate) hazardous environments have been isolated. Install this equipment only in areas and with applications known to be constantly free from hazardous atmospheres.

DANGER

POTENTIAL FOR EXPLOSION

- Install and use this equipment in non-hazardous locations only.
- Do not install or use this equipment in applications which could generate hazardous atmospheres, such as applications which use flammable refrigerants.

Failure to follow these instructions will result in death or serious injury.

For information regarding the use of control equipment in applications capable of generating hazardous materials, please contact the relevant national regulatory bodies or certifying authorities.

WARNING

UNINTENDED EQUIPMENT OPERATION

Install and use the equipment in compliance with the conditions described in the general technical specifications.

Failure to follow these instructions can result in death, serious injury, or equipment damage.

2.4. COMMENTS CONCERNING INSTALLATION

WARNING

UNINTENDED EQUIPMENT OPERATION

- Use appropriate safety interlocks where personnel and/or equipment hazards exist.
- Install and operate this equipment in an enclosure appropriately rated for its intended environment and secured by a keyed or tooled locking mechanism.
- Power line and output circuits must be wired and fused in compliance with local and national regulatory requirements for the rated current and voltage of the particular equipment.
- Do not use this equipment for safety-critical functions.
- Do not disassemble, repair, or modify this equipment.

Failure to follow these instructions can result in death, serious injury, or equipment damage.

For mechanical sizes see [4.5. Mechanical dimensions page 38](#).

EWCM 400D PRO A-STD controllers are designed for DIN rail or panel mounting.

When handling the equipment, take care to avoid damage caused by electrostatic discharge. In particular, the unshielded connectors and in certain cases the open circuit boards are extremely vulnerable to electrostatic discharge.

⚠ WARNING

UNINTENDED EQUIPMENT OPERATION DUE TO ELECTROSTATIC DISCHARGE

- Keep the equipment in the protective packaging until ready for installation.
- The equipment must only be installed in type-approved casing and/or in points that prevent accidental access and provide protection from electrostatic discharge.
- When handling sensitive equipment, use an antistatic bracelet or equivalent earthed protective device against electrostatic discharge.
- Before handling the equipment, always discharge the static electricity from the body by touching an earthed surface or type-approved antistatic mat.

Failure to follow these instructions can result in death, serious injury, or equipment damage.

2.5. SKP 10 INSTALLATION

The instrument is designed for panel mounting (refer to **Fig. 1 page 15**),

1. Make a 71x29 mm hole (2.80x1.14 in.).
2. Insert the instrument.
3. Fix it using the brackets supplied.

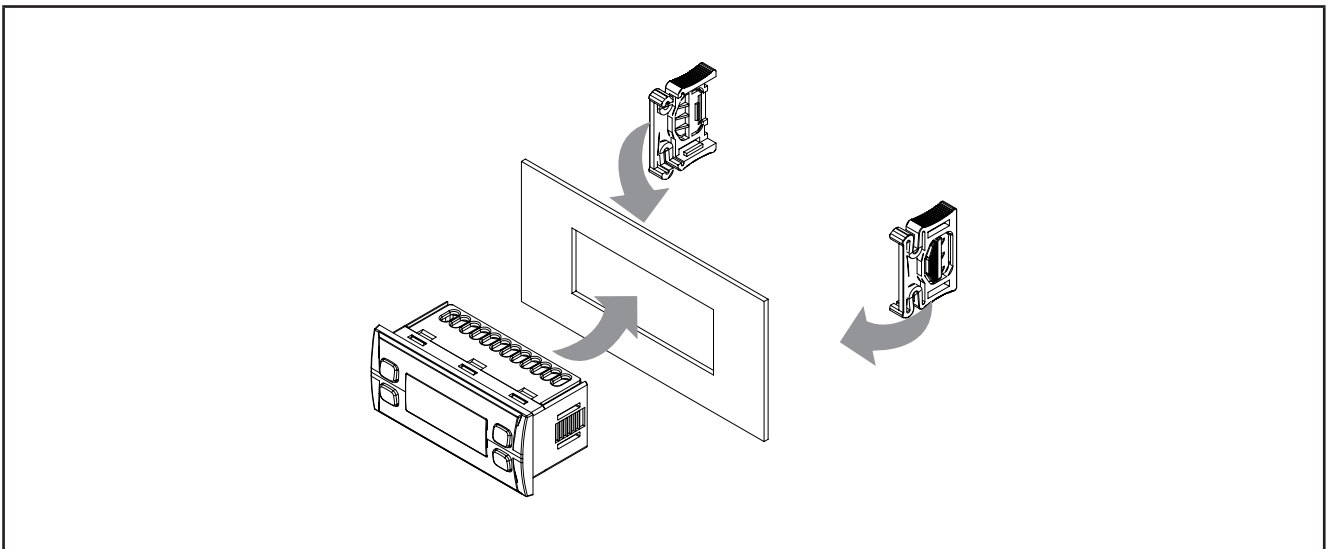

Fig. 1. Installation example

2.6. EWCM 400D PRO A-STD INSTALLATION

The instrument is designed for 4DIN rail mounting (refer to Fig. 2 page 16, Fig. 3 page 16, Fig. 4 page 17 and Fig. 5 page 17).

Follow the instructions below for installation on DIN rail:

1. Move the two spring docking devices to their standby position (use a screwdriver to press against the relative compartments);
2. Then install the instrument on the DIN rail;
3. Press on the “spring docking devices” to set them to the locked position.

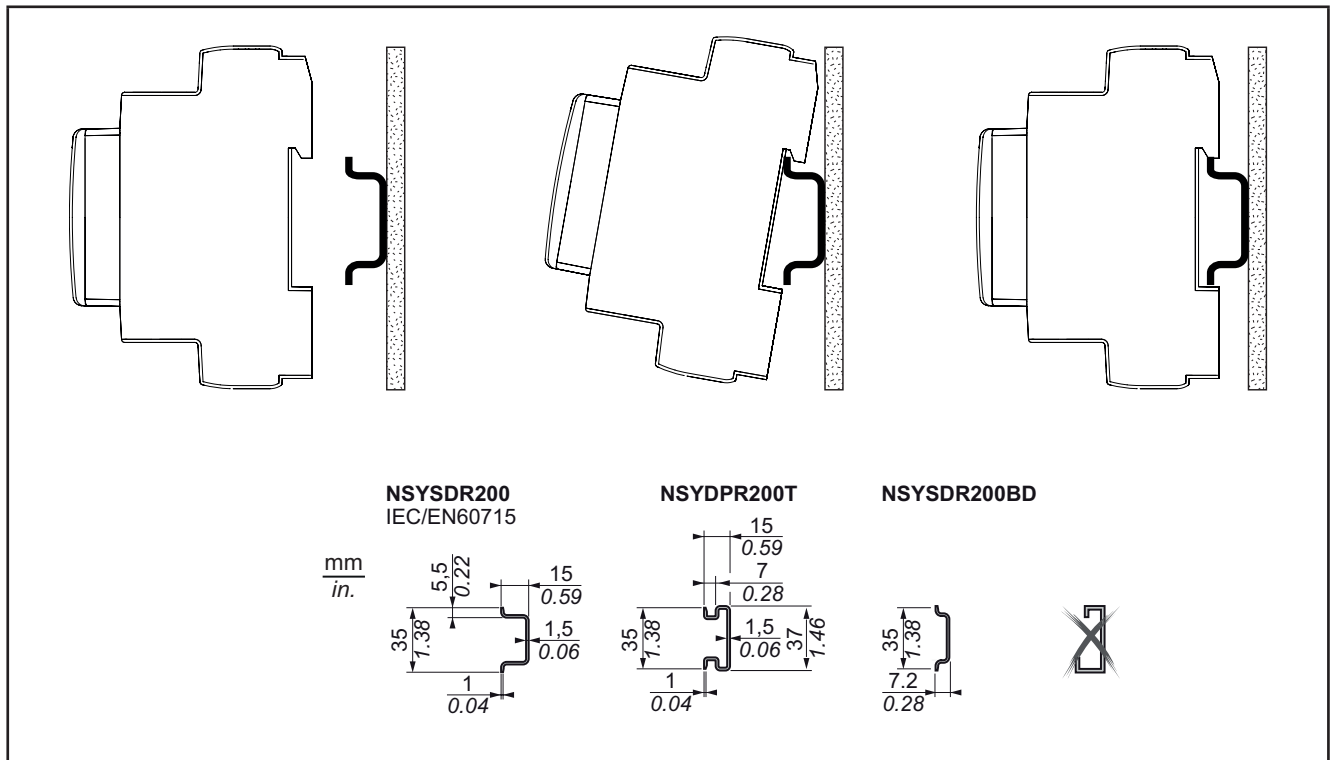

Fig. 2. DIN rail installation – side view

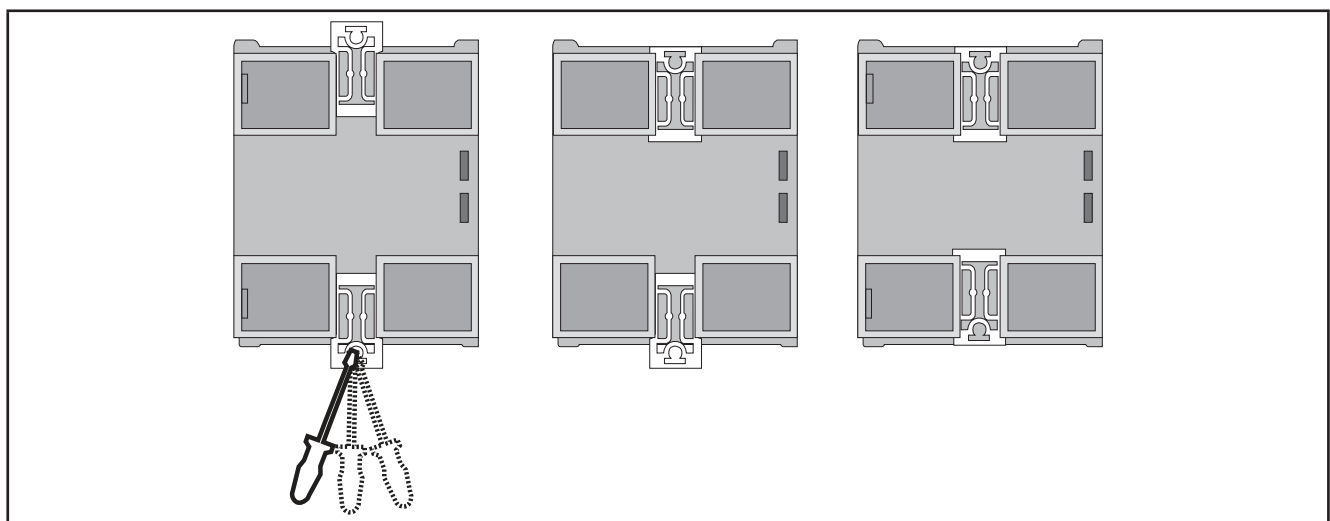

Fig. 3. DIN rail installation - rear view

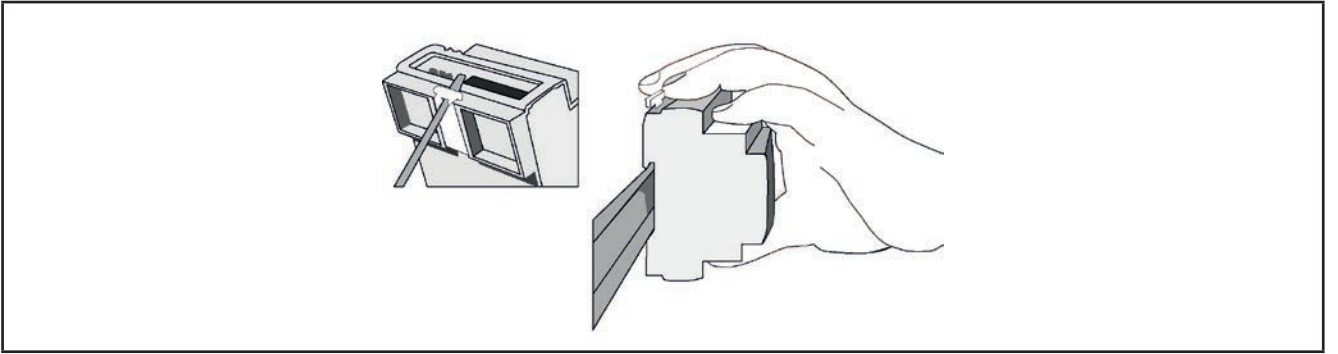

Fig. 4. DIN rail installation – ¾ view

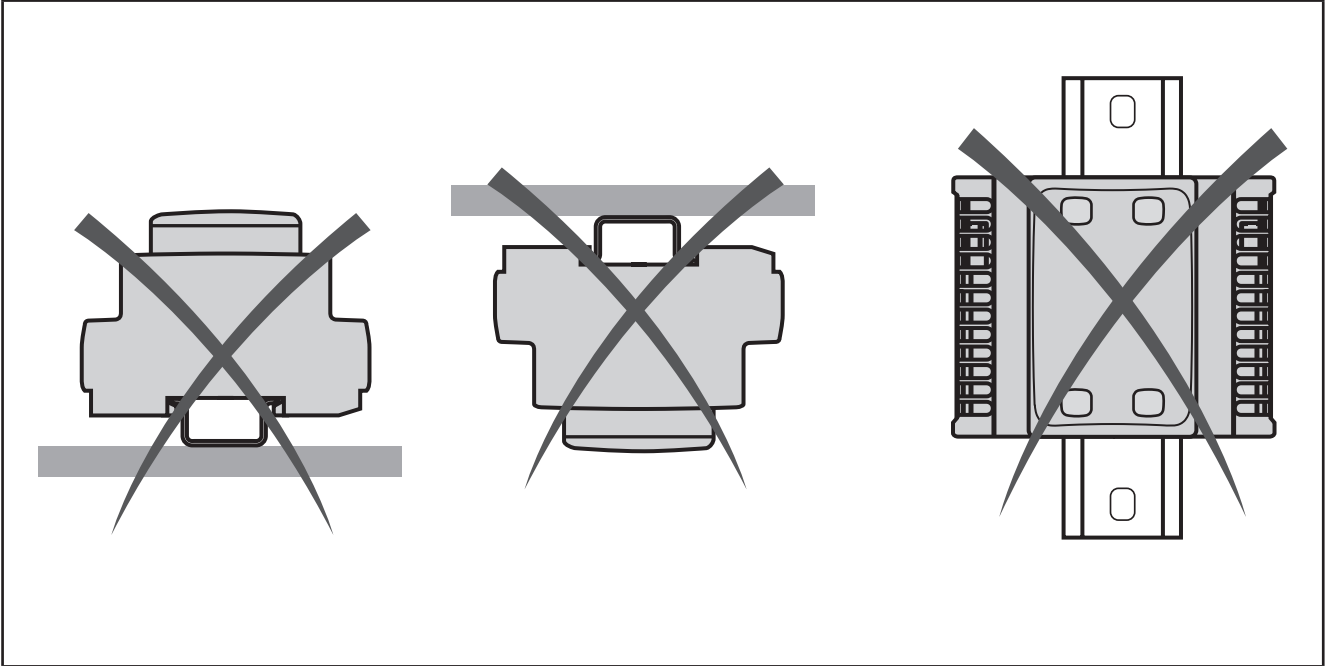

Fig. 5. DIN rail mount

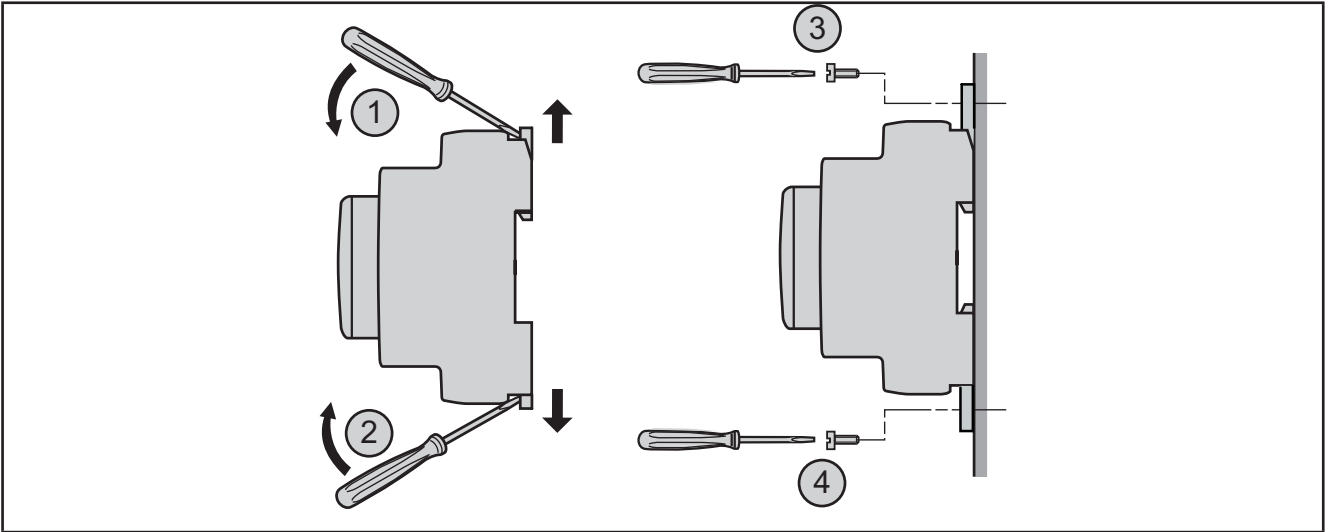

Fig. 6. Panel mount

2.7.

The **EWCM 400D PRO A-STD** controller is designed as a class IP20 product and should be installed in a cabinet suitably classified for its intended environment and protected by a key or locking mechanism. There are 3 types of distance to be observed, including:

- The **EWCM 400D PRO A-STD** controller and all sides of the cabinet (including the panel door).
- The terminal blocks for the **EWCM 400D PRO A-STD** controller and the wiring ducts. These distances reduce electromagnetic interference between the controller and the cable ducts.
- The **EWCM 400D PRO A-STD** controller and the other heat generating devices installed in the same cabinet.

⚠ WARNING

UNINTENDED EQUIPMENT OPERATION

- Place the devices dissipating the most heat at the top of the cabinet and ensure suitable ventilation.
- Do not place this equipment near or above any devices which could cause overheating.
- Install the device in a point that guarantees the minimum distances from all structures and adjacent equipment as indicated in this document.
- Install all equipment in conformity with the technical specifications given in the corresponding documentation.

Failure to follow these instructions can result in death, serious injury, or equipment damage.

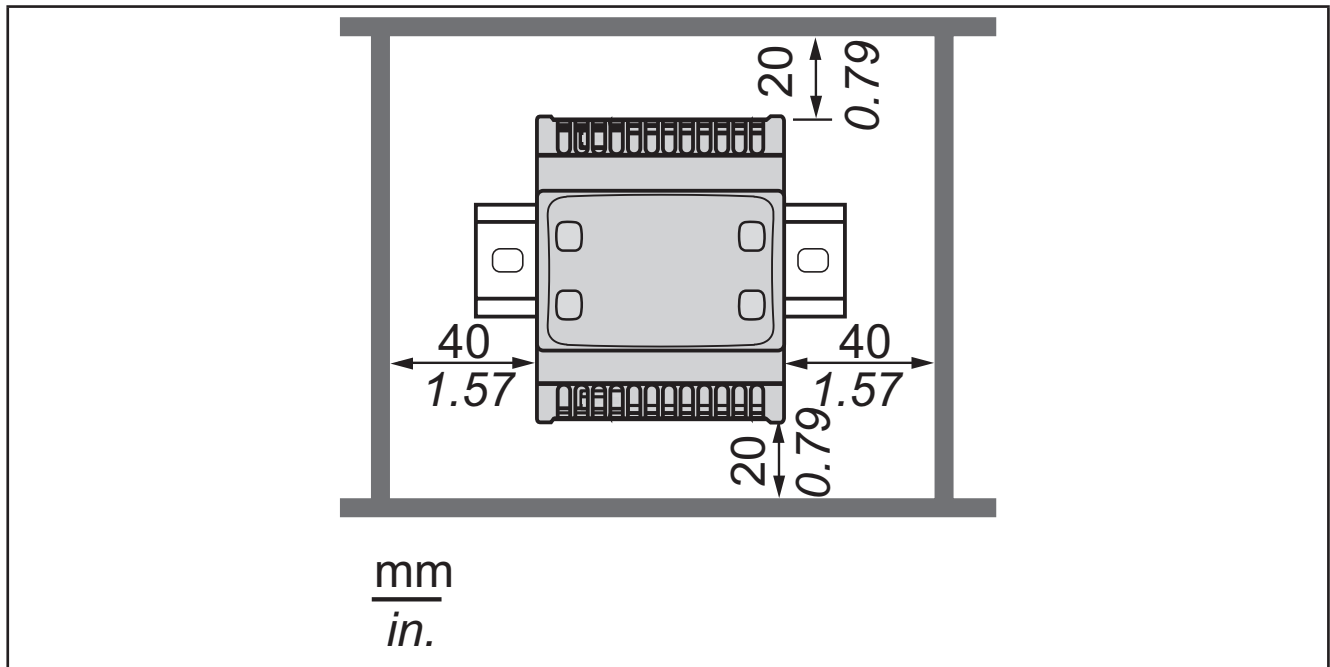

Fig. 7. Distances

CHAPTER 3

Electrical connections

3.1. BEST WIRING PRACTICES

The following information describes the wiring guidelines and the best practices to follow when using the **EWCM 400D PRO A-STD** compressor rack controllers.

DANGER

HAZARD OF ELECTRIC SHOCK, EXPLOSION OR ARC FLASH

- Disconnect all power from all equipment including connected devices prior to removing any covers or doors, or installing or removing any accessories, hardware, cables or wires except under the specific conditions specified in this hardware guide.
- Always use a properly rated voltage sensing device to confirm the power is off where and when indicated.
- Before restoring the power supply, replace and secure all covers, hardware components and cables.
- For all the devices requiring it, make sure there is an effective ground connection.
- Use only the specified voltage when operating this device and any associated products.

Failure to follow these instructions will result in death or serious injury.

WARNING

LOSS OF CONTROL

- The control system designer must consider the potential failure modes of the control circuit and, for some critical control functions, provide a means for reaching a safe condition during and after a circuit failure. Examples of critical control functions are the emergency stop and end of travel stop, power supply cut-off and restart.
- Separate or redundant control circuits must be provided for critical control functions.
- The system control circuits can include communication connections. Keep in mind the implications of transmission delays or sudden connection failures.
- Comply with all standards regarding accident prevention and local applicable safety directives.⁽¹⁾
- Every implementation of this equipment must be tested individually and completely in order to check its proper operation before it is commissioned.

Failure to follow these instructions can result in death, serious injury, or equipment damage.

⁽¹⁾ For additional information, refer to the standards NEMA ICS 1.1 (latest edition), “Safety Guidelines for the Application, Installation, and Maintenance of Solid State Control” and NEMA ICS 7.1 (latest edition) “Safety Standards for Construction and Guide for Selection, Installation and Operation of Adjustable-Speed Drive Systems” or to equivalent standards that regulate your particular location.

3.1.1. Wiring guidelines

When wiring the controllers the following standards must be observed:

- The I/O and communication wiring must be kept separate from the electrical wiring. These two types of wiring must be kept in separate raceways.
- Make sure that the operating conditions and surroundings comply with the specification values.
- Use wires of the correct diameter and suited to the voltage and current requirements.
- Use copper conductors (obligatory).
- Use twisted-pair shielded wires for analog and/or high-speed I/Os.
- Use twisted-pair shielded wires for networks and field buses.

Use correctly earthed shielded wires for all analog and high-speed inputs and outputs and communication connections. If shielded wires cannot be used for these connections, the electromagnetic interference may deteriorate the signal. Deteriorated signals can result in the controller, modules or attached equipment operating incorrectly.

⚠ WARNING

UNINTENDED EQUIPMENT OPERATION

- Use shielded wires for all high speed I/O, analog I/O and communication signals.
- Earth the wire shields for all analog I/O, high-speed I/O and communication signals in a single point ⁽¹⁾.
- Lay the communication and I/O cables separately from the power cables.
- Reduce the length of the connections as much as possible and avoid winding them around electrically connected parts.









Failure to follow these instructions can result in death, serious injury, or equipment damage.

⁽¹⁾ Earthing in several points is permitted if the connections are made to an equipotential earth surface that is sized to avoid damage to the cable shields in the event of a short circuit in the power supply.

NOTE: Lay the main wiring (power wires) separately from the secondary wiring (very low voltage wire coming from intermediate power sources). Where this is not possible, double insulation is required in the form of cable recesses or raceways.

3.1.2. Rules for screw-type terminal boards

The table below illustrates the types of cables and wire cross-sections for a screw-type terminal board with **5.00 mm spacing**:

$\frac{\text{mm}}{\text{in.}}$	$\frac{7}{0.28}$								
mm^2		0.2...2.5	0.2...2.5	0.25...2.5	0.25...2.5	2 x 0.2...1	2 x 0.2...1.5	2 x 0.25...1	2 x 0.5...1.5
AWG		24...13	24...13	22...13	22...13	2 x 24...18	2 x 24...16	2 x 22...18	2 x 20...16



 Ø 3,5 mm (0.14 in.)		N•m	0.5...0.6
		lb-in	4.42...5.31

Fig. 8. Spacing 5.00 mm (0.197 in.)

Only use copper wires.

⚡ ⚠ DANGER

LOOSE WIRING CAN RESULT IN ELECTRIC SHOCK

Tighten the connections in compliance with the technical specifications for torque values.

Failure to follow these instructions will result in death or serious injury.

⚠ DANGER

FIRE HAZARD

- Use only the recommended wire cross-sections for the current capacity of the I/O channels and the electrical power.
- For wiring a 2 A relay output, use conductors with a cross-section of at least 0.5 mm² (AWG 20) with a nominal temperature value of at least 80°C (176°F).

Failure to follow these instructions will result in death or serious injury.

3.1.3. Protecting the outputs from damage from inductive loads

Depending on the load a protection circuit may be required for controller outputs and certain modules. Inductive load switching may create voltage impulses that damage or short circuit or reduce the life of the output devices.

⚠ CAUTION

DAMAGE TO OUTPUT CIRCUITS DUE TO INDUCTIVE LOADS

Use an external protective device or circuit able to reduce the risks caused by voltage impulses in the switching of inductive loads.

Failure to follow these instructions can result in injury or equipment damage.

If the controller or module has relay outputs, these types of outputs can cope with up to 240 Vac. Damage from inductive loads to these types of outputs can cause the contacts to weld and lead to the loss of control. Each inductive load must include a protective device such as a peak limiter, an RC circuit or a flyback diode. These relays do not support capacitive loads.

⚠ WARNING

RELAY OUTPUTS WELDED TO CLOSED POSITION
--

- | |
|---|
| <ul style="list-style-type: none">• Always protect the relay outputs from damage resulting from alternating current inductive loads using a suitable external protective device or circuit.• Do not connect the relay outputs to capacitive loads. |
|---|

Failure to follow these instructions can result in death, serious injury, or equipment damage.

Protection circuit A: this protection circuit can be used for both direct and alternating current load circuits.

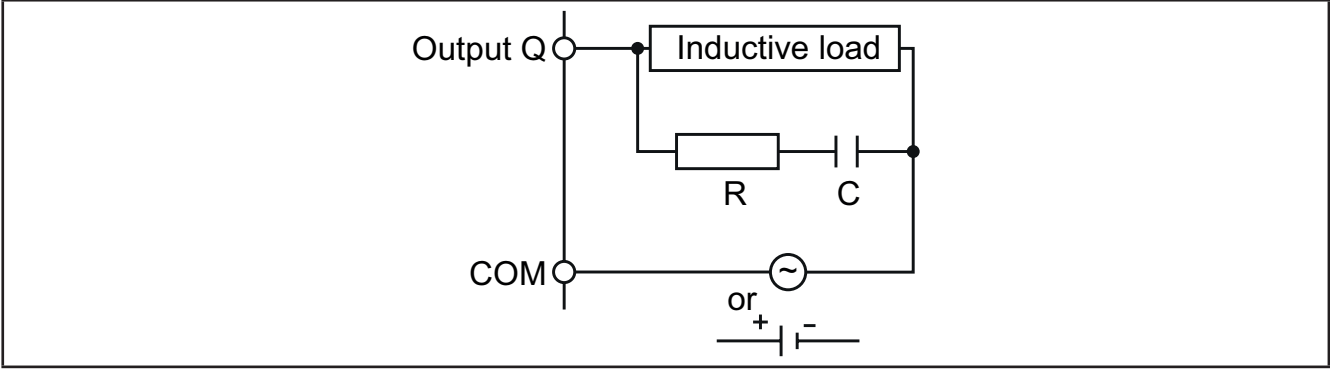

Fig. 9. Protection circuit A

C Value from 0.1 to 1 μF

R Resistor with approximately the same load resistance value

Protection circuit B: this protection circuit can be used for direct current load circuits.

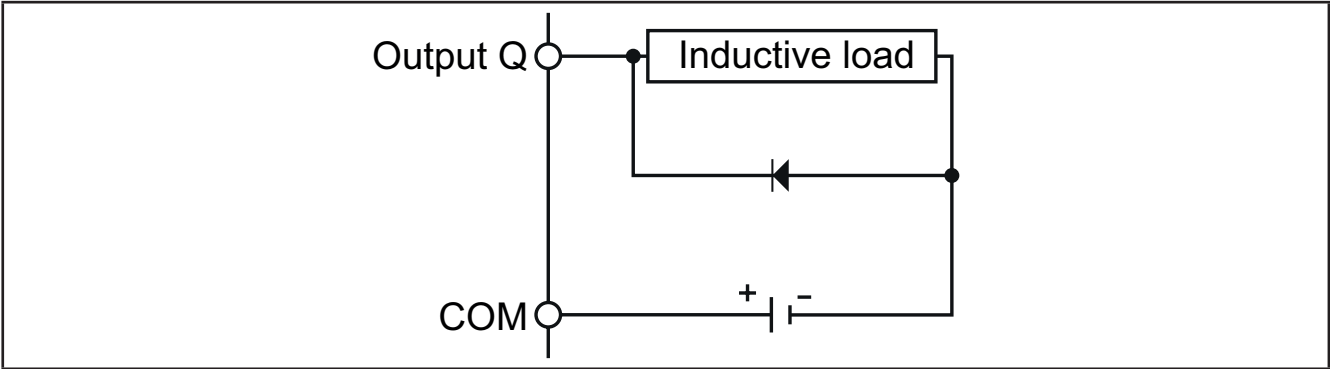

Fig. 10. Protection circuit B

Use a diode with the following nominal characteristics:

- Maximum inverse voltage: load circuit voltage x 10.
- Direct current: greater than the load current.

Protection circuit C: this protection circuit can be used for both direct and alternating current load circuits.

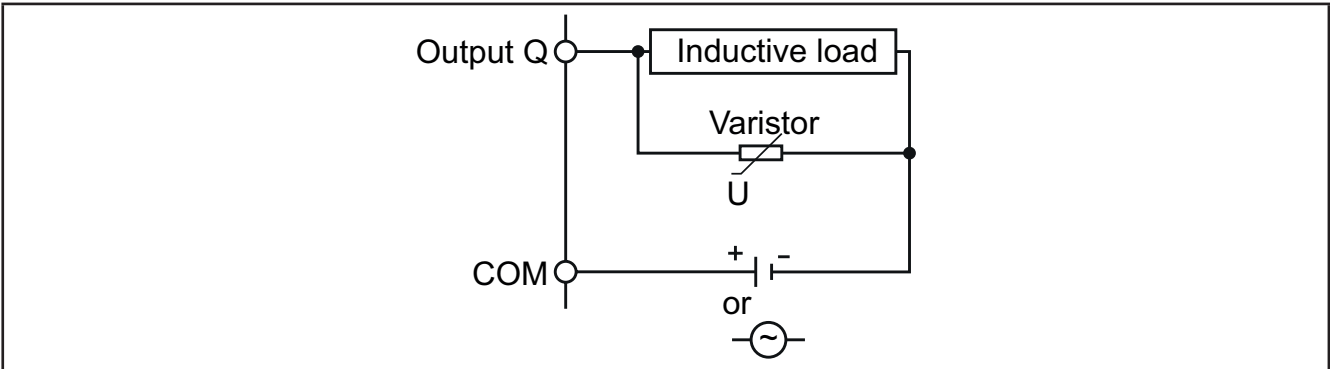

Fig. 11. Protection circuit C

In applications in which the inductive load is frequently and/or rapidly switched on and off, check that the maximum continuous energy (J) of the varistor is 20% or more higher than the peak load energy.

NOTE: Place the protection devices as close as possible to the load.

3.1.4. Specific considerations for handling

When handling the equipment, take care to avoid damage caused by electrostatic discharge. In particular, the unshielded connectors and in certain cases the open circuit boards are extremely vulnerable to electrostatic discharge.

WARNING

UNINTENDED EQUIPMENT OPERATION DUE TO ELECTROSTATIC DISCHARGE

- Keep the equipment in the protective packaging until ready for installation.
- The equipment must only be installed in type-approved casing and/or in points that prevent accidental access and provide protection from electrostatic discharge.
- When handling sensitive equipment, use an antistatic bracelet or equivalent earthed protective device against electrostatic discharge.
- Before handling the equipment, always discharge the static electricity from the body by touching an earthed surface or type-approved antistatic mat.

Failure to follow these instructions can result in death, serious injury, or equipment damage.

3.1.5. Analog inputs-probes

Probes have no connection polarity and can be extended using normal bipolar cable (note that the extension of the probes influences the instrument's EMC electromagnetic compatibility: take great care with the wiring).

WARNING

UNINTENDED EQUIPMENT OPERATION

The device's signal cables (probes, digital inputs, communication and relative power supplies), must be laid separately from the power cables.

Failure to follow these instructions can result in death, serious injury, or equipment damage.

NOTICE

INOPERABLE DEVICE

- Before switching on the electrical power, check all the wiring connections.
- Do not insert more than one wire per terminal board connector unless you are using the lugs (ferrules) specified above.

Failure to follow these instructions can result in equipment damage.

NOTE: apply the electrical power supply to all externally powered devices after applying the electrical power to the EWCM 400D PRO A-STD controllers.

3.1.6. Serial connections

TTL

Use a 5-wire TTL cable with a maximum length of 3 m (9.84 in.).

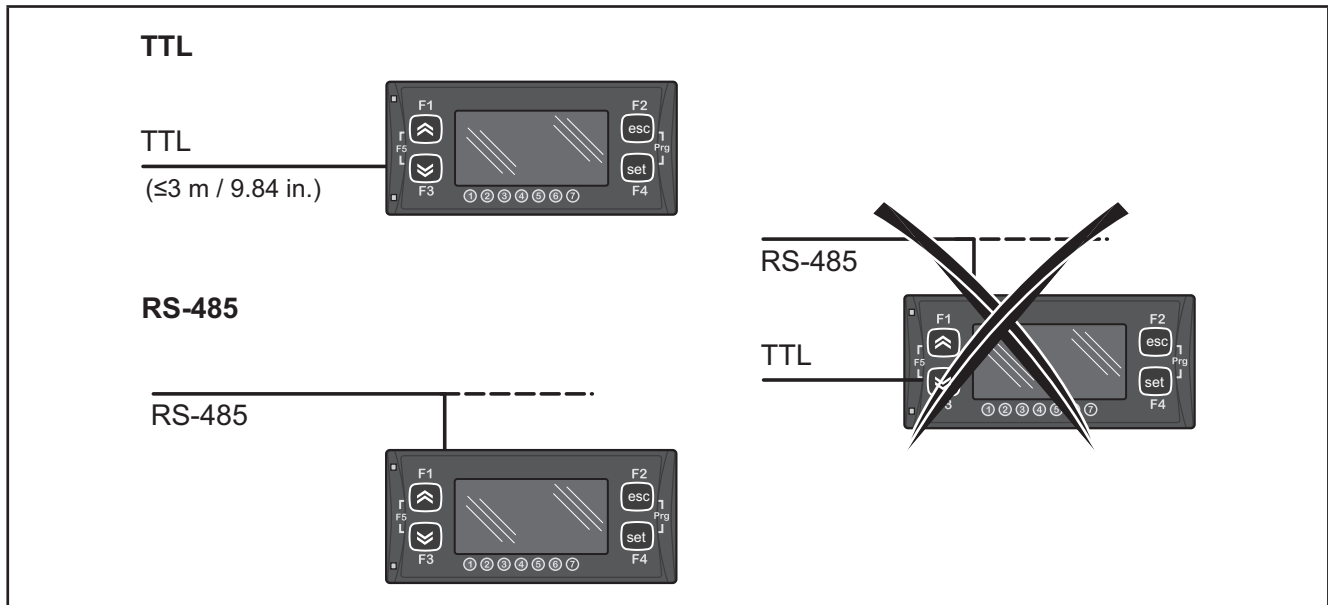

Fig. 12. Serial connection: TTL / RS-485

NOTICE

INOPERABLE DEVICE

Only connect the RS-485 serial or the TTL (for UNICARD/DMI/MFK).

Failure to follow these instructions can result in equipment damage.

3.2. ELECTRIC DIAGRAMS

Incorrect wiring will cause irreversible damage to the controllers.

NOTICE

INOPERABLE DEVICE

Before switching on the electrical power, check all the connections.

Failure to follow these instructions can result in equipment damage.

3.2.1. EWCM 436D PRO STD

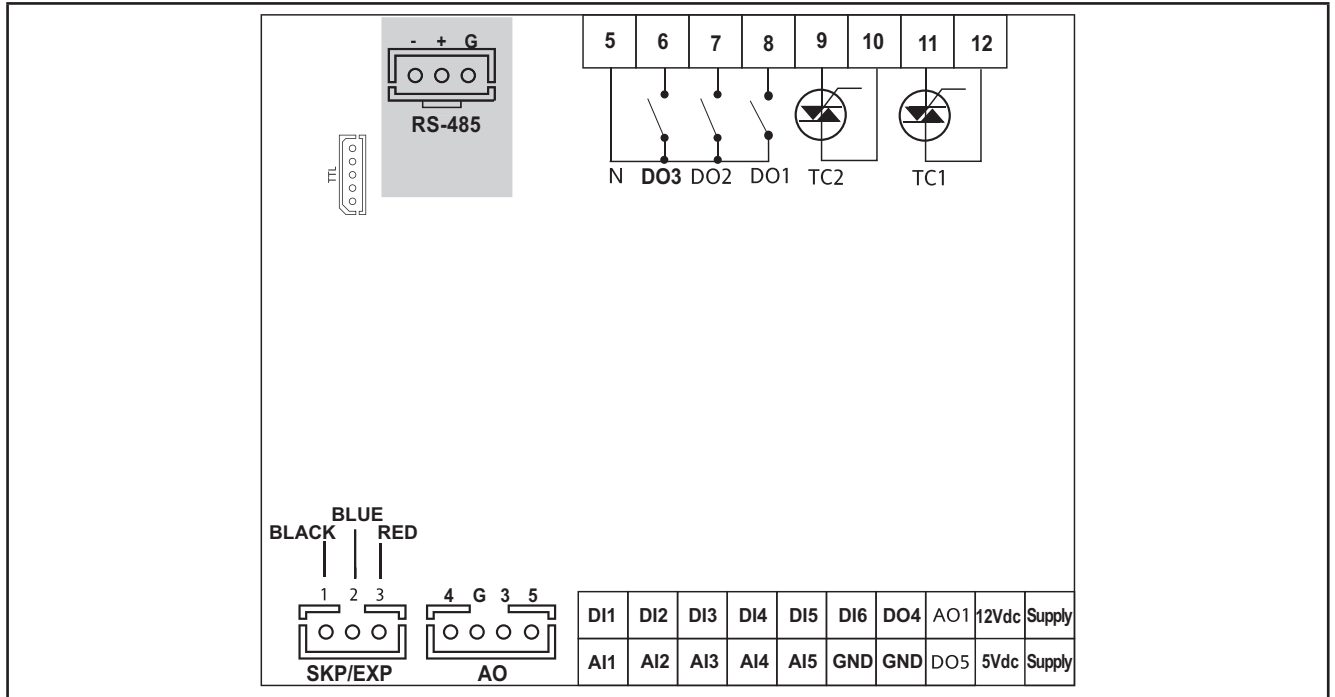

Fig. 13. EWCM 436D PRO STD

3 digital outputs with hazardous voltage 2 A max. 240 Vac max.	[DO1, DO2, DO3]
6 analog outputs	2 analog outputs with hazardous voltage 2 A 240 Vac [TC1, TC2]
	1 Open Collector PPM/PWM low voltage analog output (SELV (§)) [AO1]
	3 low voltage (SELV (§)) analog outputs [AO3-4-5]: <ul style="list-style-type: none"> • 2 x 0...10 V [AO3-4] outputs • 1 x 4...20 mA/0...20 mA output [AO5]
6 digital inputs	[DI1...DI6]
3 NTC* / Digital*** inputs	[AI1, AI2, AI5]
2 NTC / voltage, current** / Digital*** inputs	[AI3, AI4]
2 low voltage Open Collector outputs (SELV (§))	[DO4] [DO5]

*Type SEMITEC 103AT (10 kΩ at 25°C)

**0...20 mA / 4...20 mA current input or 0...5 V / 0...10 V / 0...1 V voltage input

***voltage-free digital input

(°) closing current for 0.5 mA ground

(§) SELV: (SAFETY EXTRA LOW VOLTAGE)

POWER SUPPLY	12...24 Vac - 6 VA
5 Vdc	Auxiliary power supply 5 Vdc 20 mA max.
12 Vdc	Auxiliary power supply 12 Vdc 70 mA max.
N	Neutral
SKP/EXP	SKP 10 (max. 10 m - 32.8 ft)
TTL	TTL serial for MFK / UNICARD connection
RTC	RTC supplied as standard
RS-485	RS-485 serial on board for connection to supervisor

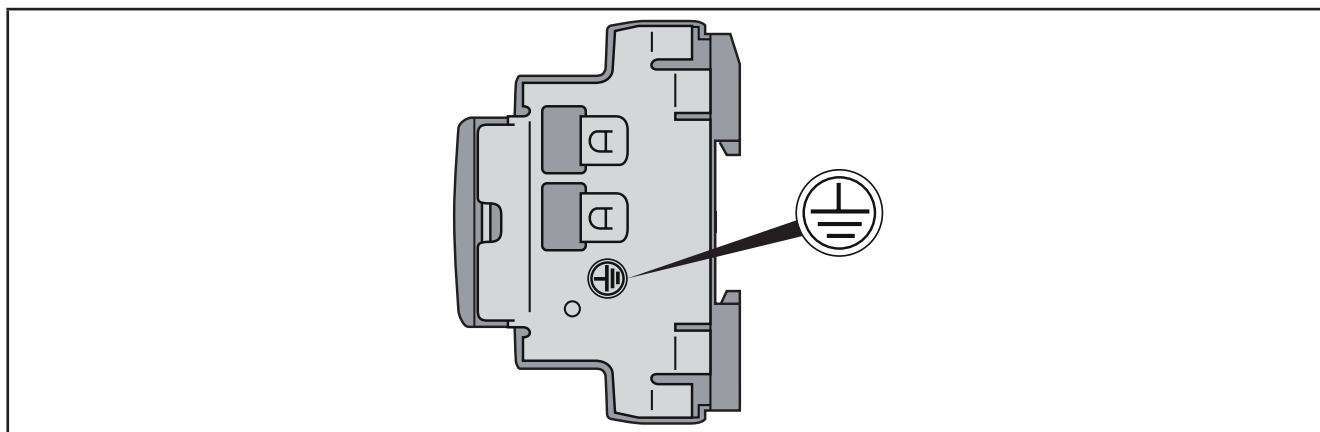

Fig. 14. EWCM 436D PRO STD ground

⚡ ⚠ DANGER

RISK OF ELECTRIC SHOCK

Always use the ground connection on the side of the device to create a safety grounding system.
Failure to follow these instructions will result in death or serious injury.

NOTICE

INOPERABLE DEVICE

Power the device only with alternating current.

Failure to follow these instructions can result in equipment damage.

NOTE: the connection diagrams illustrated below are presented in conformity with the technical documentation from the respective manufacturers listed in the boxes. Manufacturer specifications are subject to change without notice.

3.2.2. EWCM 455D PRO STD / EXP 455D PRO / 455P PRO STD

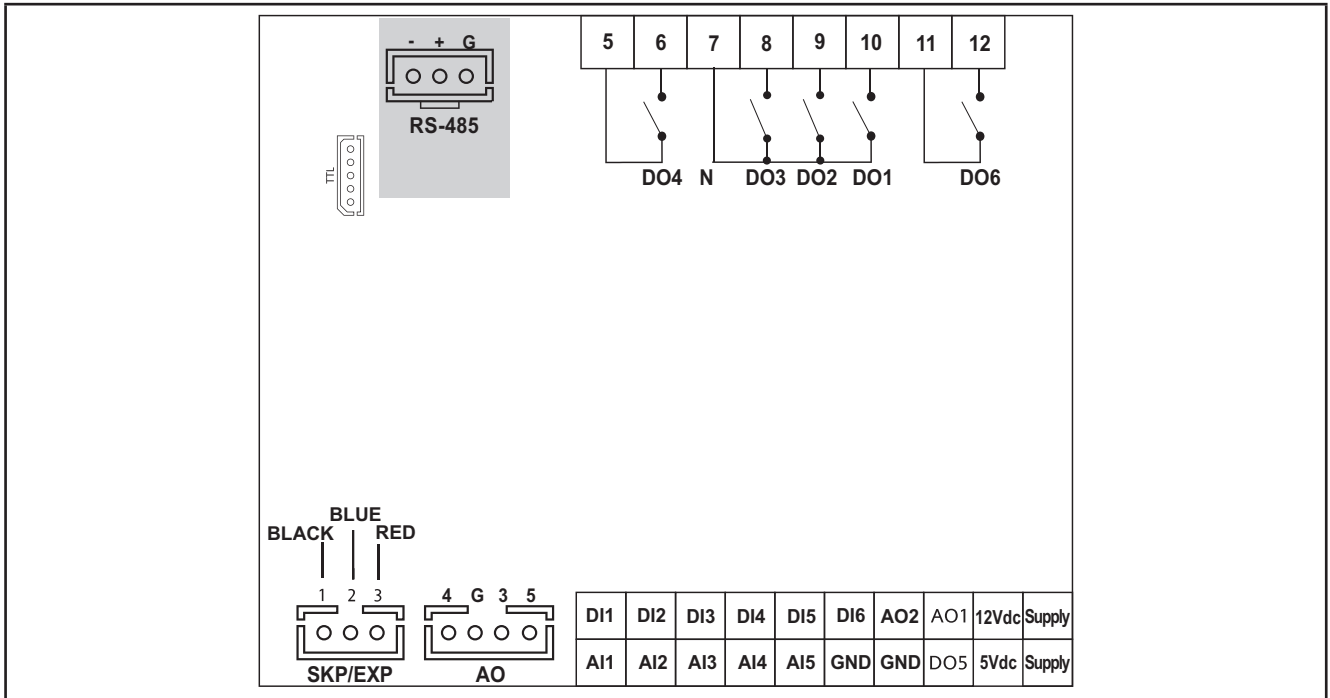

Fig. 15. EWCM 455D PRO STD / EXP 455D PRO

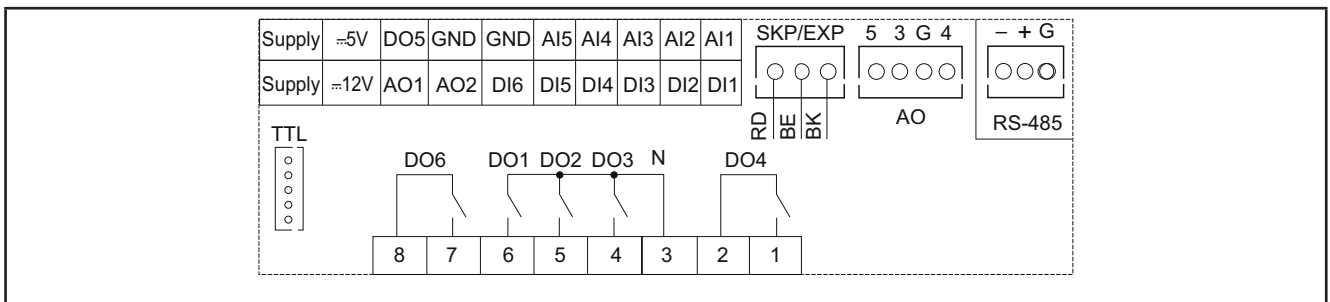

Fig. 16. EWCM 455P PRO STD

5 digital outputs with hazardous voltage 2 A max. - 240 Vac max.	[DO1, DO2, DO3, DO4, DO6]
5 analog outputs	2 Open Collector PPM/PWM low voltage analog outputs (SELV (§)) [AO1, AO2]
	3 low voltage (SELV (§)) analog outputs [AO3-4-5]
6 digital inputs	[DI1...DI6]
3 NTC* / Digital*** inputs	[AI1, AI2, AI5]
2 NTC / voltage, current** / Digital*** inputs	[AI3, AI4]
1 low voltage Open Collector output (SELV (§))	[DO5]

*Type SEMITEC 103AT (10 kΩ at 25°C)

**0...20 mA / 4...20 mA current input or 0...5 V / 0...10 V / 0...1 V voltage input

***voltage-free digital input

(°) closing current for 0.5 mA ground

(§) SELV: (SAFETY EXTRA LOW VOLTAGE)

POWER SUPPLY	12...24 Vac - 6 VA 24 Vdc - 4 W
5 Vdc	Auxiliary power supply 5 Vdc 20 mA max.
12 Vdc	Auxiliary power supply 12 Vdc 70 mA max.
N	Neutral
SKP/EXP	SKP 10 (max. 10 m - 32.8 ft)
TTL	TTL serial for MFK, UNICARD connection
RTC	RTC supplied as standard
RS-485	On-board RS-485 serial port for connection to supervisor (EWCM 455D PRO STD only)

3.2.3. Example of low voltage/low current input/output connection

Example of current/voltage input connection

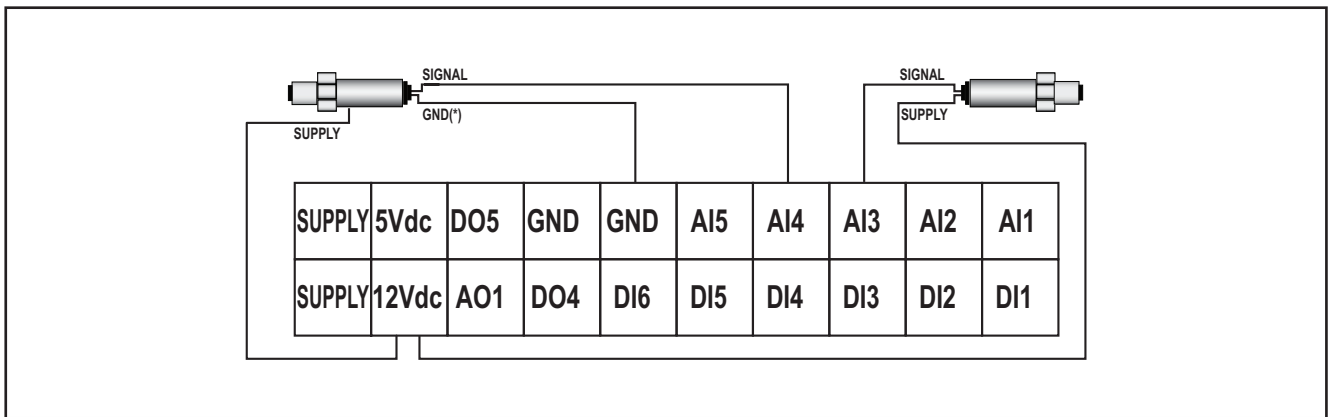

Fig. 17. Current input connection

(*) NOTE: Only in 3-wire models.

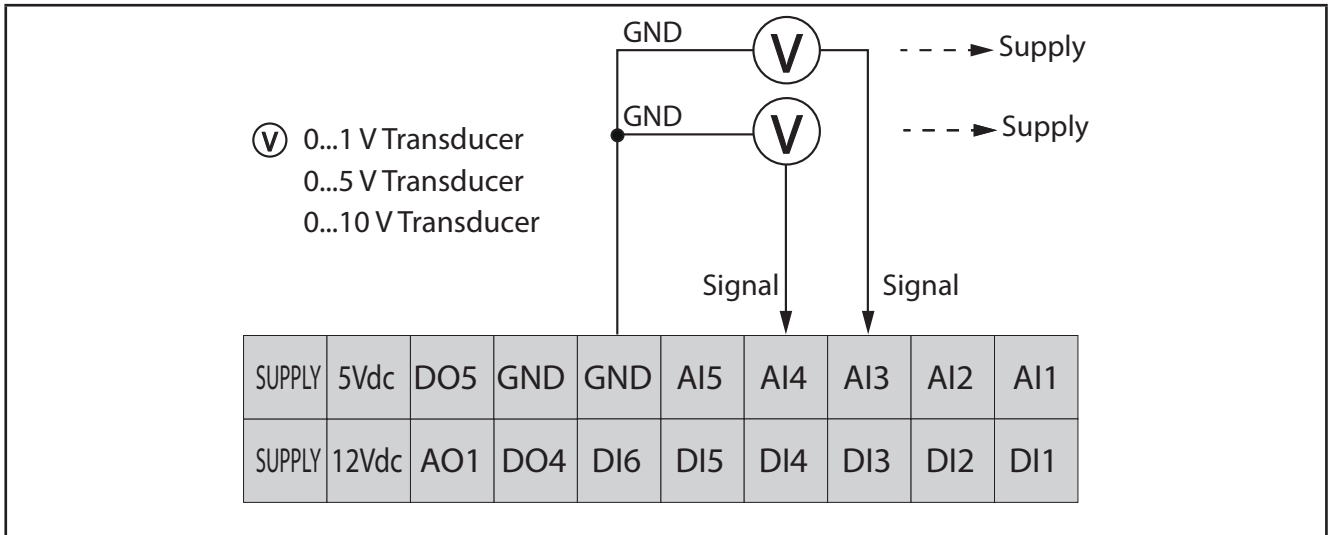

Fig. 18. Voltage input connection

NOTE: In [Fig. 18 page 28](#), Supply: transducer power supply from **EWCM 400D PRO A-STD** (5 Vdc or 12 Vdc). For more information refer to the transducer technical data sheet.

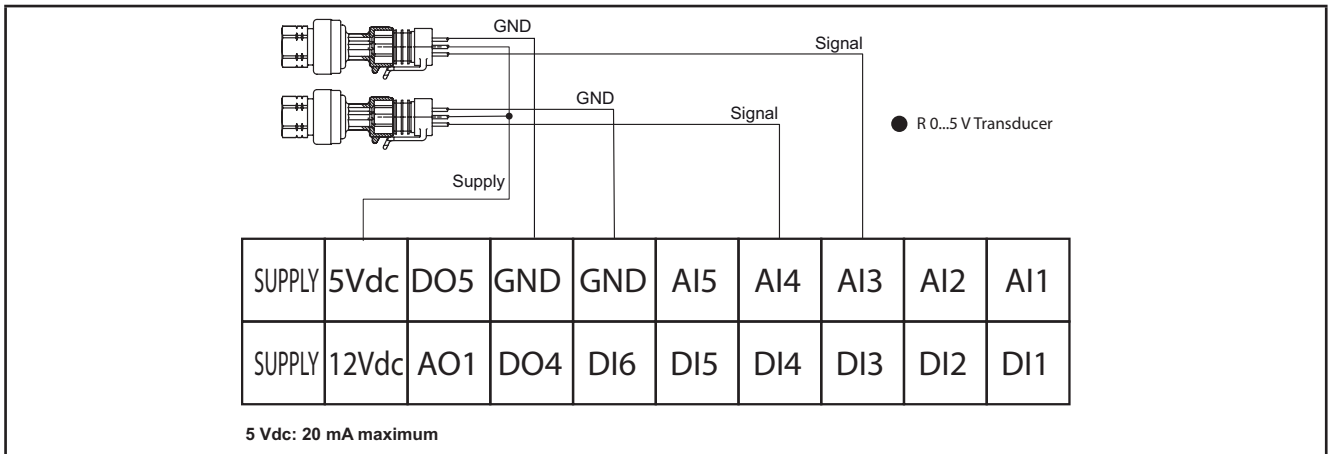

Fig. 19. Voltage connection of ratiometric inputs 0...5 V

Example of analog/digital input connection

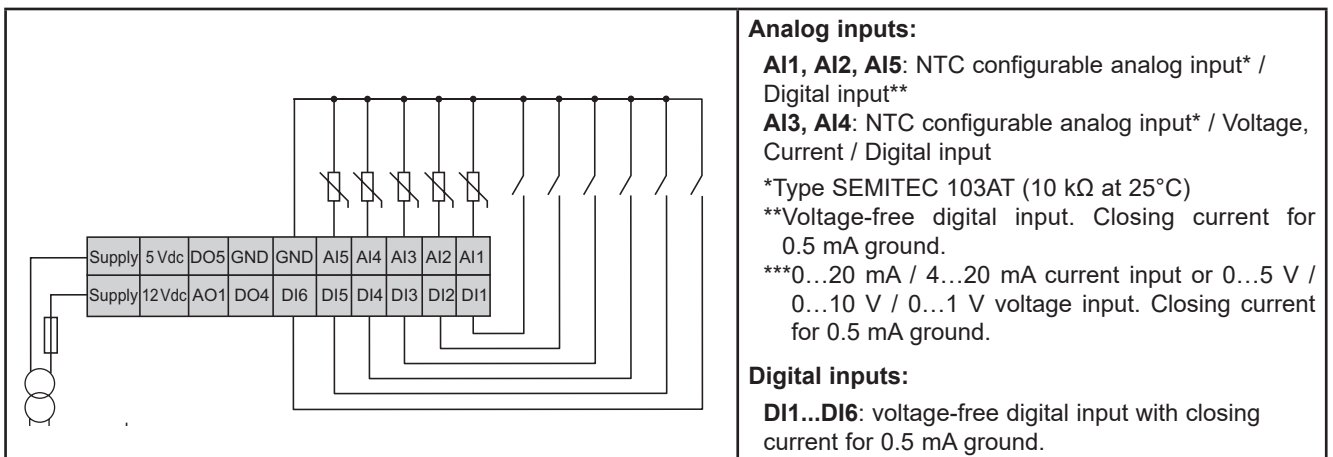

Fig. 20. Example of analog/digital input connection

Example of AO1 connection

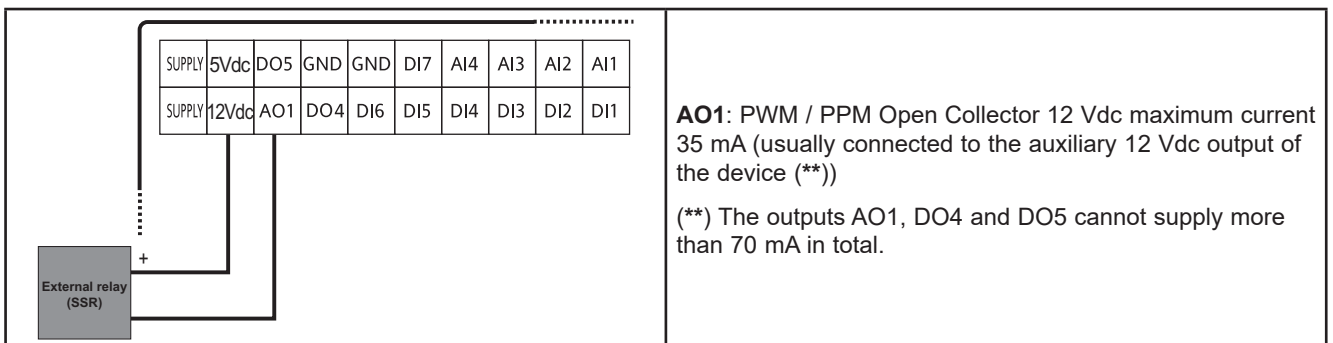

Fig. 21. Example of EWCM 436D PRO STD connection with an external relay

For versions **EWCM 455D PRO** and **EWCM 455P PRO**, **AO1** or **AO2** can be connected to an external SSR to control the solenoid valve for the Copeland digital scroll compressors.

We recommend the use of p/n SSM1A16BD (Schneider Electric). For further information, please visit the website: www.schneider-electric.com.

Example of AO3-AO4 / AO5 connection

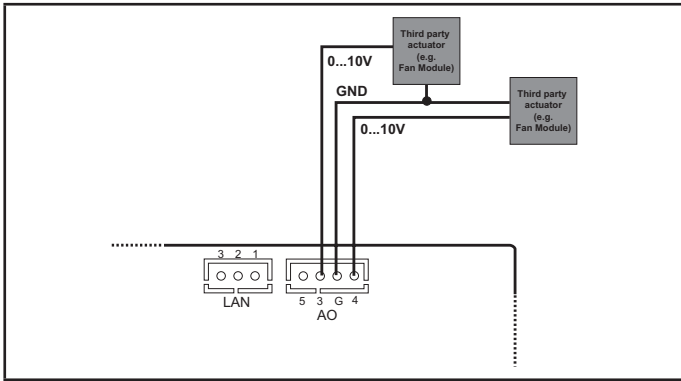

Fig. 22. Example of **EWCM 400D PRO A-STD** (AO3-AO4) connection with 1 x 0...10 V fan module

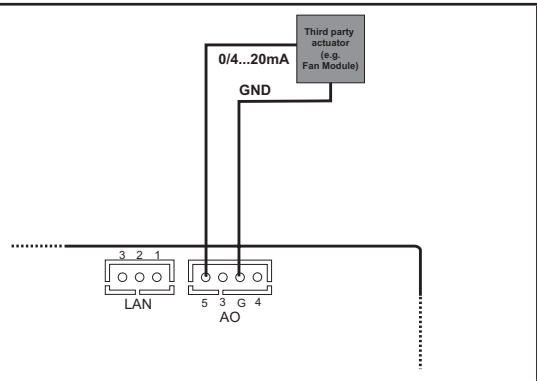

Fig. 23. Example of **EWCM 436D PRO A-STD** (AO5) connection with 1 x 0...20 mA / 4...20 mA fan module

Example of DO5 connection

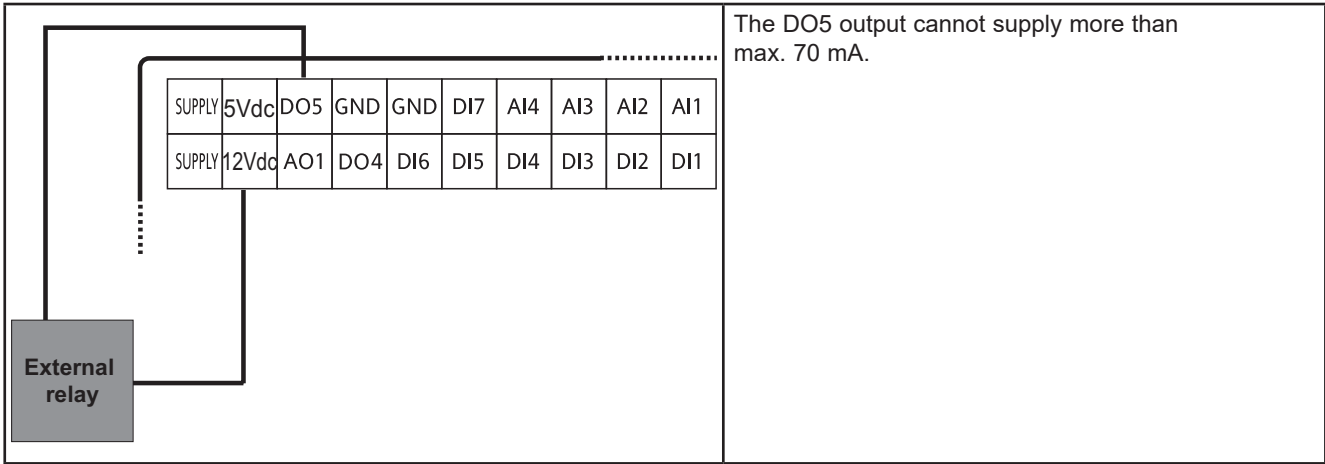

Fig. 24. Example of **EWCM 436D PRO STD** connection with an external relay

3.3. EXAMPLE OF SKP 10 CONNECTION

NOTE: The maximum distance of the wiring is 10 m (32.8 ft.).

3.3.1. SKP 10

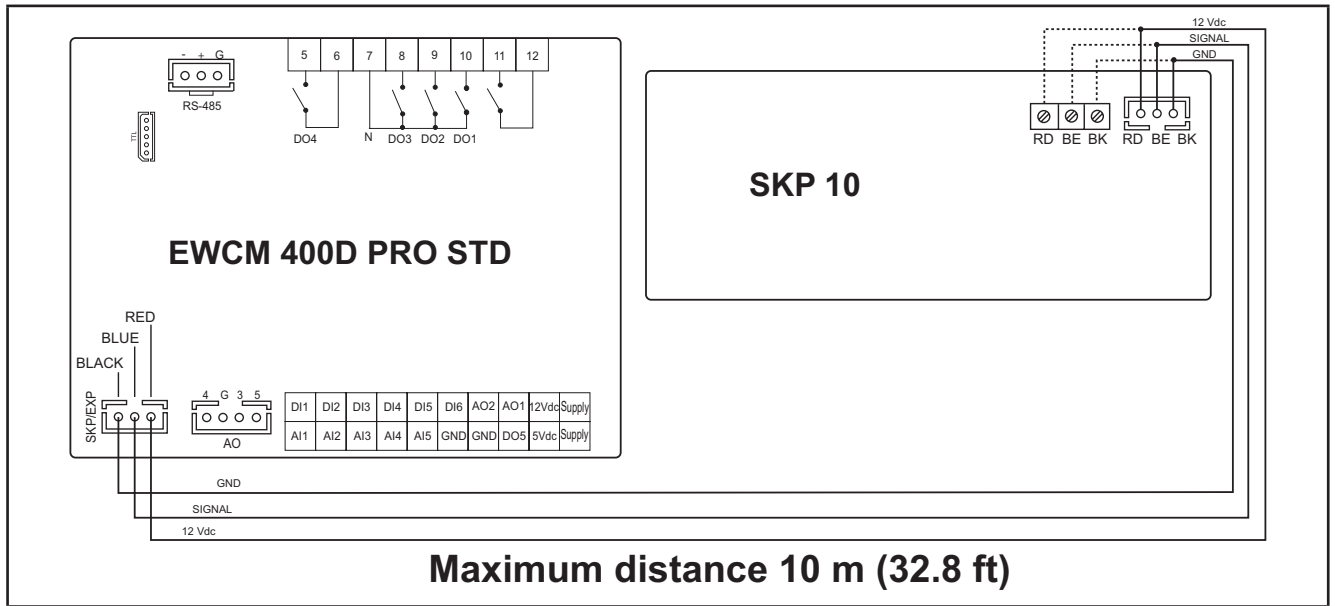

Fig. 25. Connection of EWCM 400D PRO / SKP 10

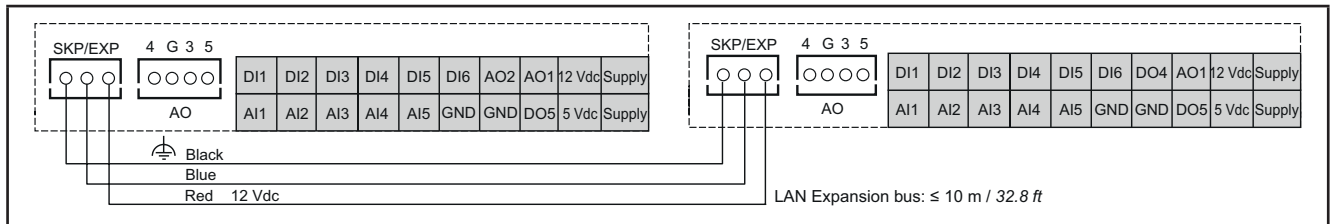

Fig. 26. Connection of EWCM 400D PRO / EXP

CHAPTER 4

Technical data

All components in the **EWCM 400D PRO A-STD** controllers system meet the European Community (CE) requirements for open devices. They must be installed in a casing or other designated place to suit the environmental conditions and minimize the risk of involuntary contact with high voltages. Use metal casings to improve the immunity of the **EWCM 400D PRO A-STD** system to electromagnetic fields. This equipment meets the CE requirements indicated in the table below.

WARNING

UNINTENDED EQUIPMENT OPERATION

Do not exceed any of the nominal values specified in this chapter.

Failure to follow these instructions can result in death, serious injury, or equipment damage.

The application of incorrect current or voltage values at the analog inputs and outputs could damage the electronic circuits. Moreover, connection of a current input device to an analog input configured for voltage and vice-versa will also damage the electronic circuits.

NOTICE

INOPERABLE DEVICE

- Do not apply voltages above 11 Vdc to the analog inputs on the controller or the inputs/outputs expansion module when the analog input is configured as a 0...10 V input.
- Do not apply currents over 30 mA to the controller analog inputs or the input/output expansion module when the analog input is configured as an input 0...20 mA or 4...20 mA.
- Make sure that the signal applied corresponds to the analog input configuration.

Failure to follow these instructions can result in equipment damage.

4.1. GENERAL SPECIFICATIONS

4.1.1. Technical data

Max. power absorbed	6 VA / 4 W
Software class	A
Overvoltage category	II
Insulating material class	IIIa
Front panel environmental protection	Open type
Rated voltage	12 ... 24 Vac 50/60 Hz / 24 Vdc ($\pm 10\%$) EPDT: 12 ... 24 Vac ($\pm 10\%$) 50/60 Hz
Control device purpose	Operating control (not safety) device
Control device construction	Built-in electronic control device
Type of load and rated current	EPDT: DO1...DO3: maximum 2 A, maximum 240 Vac resistive EPDT: TC1, TC2: 2 A, 240 Vac resistive EP5-/EPD0: DO1...DO3, DO4, DO6: maximum 2 A, maximum 240 Vac resistive EPE: DO1...DO3, DO4, DO6: 2 A, 240 Vac resistive
Protection rating provided by outer casing	IP20
Terminals that can be connected to external wires, indicating whether they are suitable for phase, neutral or both	See "Rules for screw-type terminal boards"
Environmental operating conditions	EPD0-/EPE: -20 ... 55°C (-4 ... 131°F) 10 ... 90% RH EPDT: -20 ... 65°C (-4 ... 149°F); 10 ... 90% RH
Assembly surface temperature limits	90°C (194°F)
Electric shock protection	Class II control designed for use in class I equipment
Mounting method	EPD-/EP5: DIN rail mount. EPE: Panel mount
Control device grounding method	See box
Transportation and storage conditions	-40 ... 85°C (-22 ... 185°F) 10 ... 90% RH
Type of Action	1.C
Electrical stress period for insulating parts	Long period (IEC/EN60730 / UL60730)
Pollution class	2
Nominal pulse voltage	2500 V

4.2. I/O FEATURES

4.2.1. EWCM 436D PRO STD

Type and Label	Description
Digital inputs DI1 ... DI6	6 voltage-free digital inputs Closure current for ground: 0.5 mA.
Hazardous voltage digital outputs DO1 ... DO3	3 relays maximum 2 A 240 Vac resistive maximum;
TC1, TC2	TRIAC 2 A 240 Vac resistive Resolution: 1% Remote control switches downstream of the TRIAC are NOT permitted
Low voltage analog outputs (SELV) PWM/PPM OC AO1	Open collector PWM/PPM outputs Accuracy: 2% Nominal range 0...16.9 Vdc (12 Vac rectified) Closure at 12 Vdc * Maximum current 35 mA* (min. load 340 Ω at 12 Vdc)
Low voltage (SELV) analog outputs AO3, AO4	0...10 V outputs maximum 28 mA** at 10 V (minimum load resistance 360 Ω) Precision 2% of integral scale Resolution: 1%
AO5	1 x 0... 10 V or 4..20 mA / 0...20 mA output Precision 2% of integral scale Resolution: 1% • 0/4...20 mA output, max. load (max. load resistance 350 Ω)**
Analog inputs AI1 ... AI5	See tables (Analog inputs)
Open Collector low voltage (SELV) digital output DO4, DO5	2 Open Collector outputs * Max. current 35 mA* at 12 Vdc

*The outputs AO1 and DO5 (usually connected to the device's auxiliary 12 Vdc output) cannot deliver more than 70 mA in total. Also consider any other loads connected to the same 12 Vdc auxiliary output.

If the **SKP 10** keypad is connected to the device, the current becomes 55 mA.

**Outputs AO3, AO4 and AO5 cannot deliver more than 40 mA total.

4.2.2. EWCM 455D PRO / EWCM 455P / EXP 455D PRO STD

Type and Label	Description
Digital inputs DI1 ... DI6	6 voltage-free digital inputs Closure current for ground: 0.5 mA.
Hazardous voltage digital outputs DO1 ... DO3, DO4, DO6	5 relays maximum 2 A 240 Vac maximum resistive;
Low voltage analog outputs (SELV) PWM/PPM OC AO1, AO2	Open collector PWM/PPM outputs Accuracy: 2% Nominal range 0...16.9 Vdc (12 Vac rectified) Closure at 12 Vdc * Maximum current 35 mA* (min. load 340 Ω at 12 Vdc)
Low voltage (SELV) analog outputs AO3, AO4, AO5	0...10 V outputs maximum 28 mA** at 10 V (minimum load resistance 360 Ω) Precision 2% of integral scale Resolution: 1%
Analog inputs AI1 ... AI5	See tables (Analog inputs)
Open Collector low voltage (SELV) digital output DO5	1 Open Collector output * Max. current 35 mA* at 12 Vdc

Analog inputs

	NTC (103AT) 10 kΩ at 25°C BETA 3435	Current 0...20 mA 4...20 mA	Voltage 0...10 V	Voltage 0...5 V	Voltage 0...1 V	DI
AI1	✓	-	-	-	-	✓
AI2	✓	-	-	-	-	✓
AI3	✓	✓	✓	✓	✓	✓
AI4	✓	✓	✓	✓	✓	✓
AI5	✓	-	-	-	-	✓
Range	-50...100°C (-58...212°F)	-	-	-	-	-
Accuracy	1% integral scale	1% integral scale	1% integral scale	1% integral scale	2% integral scale	
Resolution	0.1°C	0.1	0.1	0.1	0.1	
Input impedance	10 kΩ	100 Ω	21 kΩ	110 kΩ	110 kΩ	

NOTE: DI: Digital input with voltage-free contact.

Probes NOT included - contact the Eliwell Sales Office for accessories.

*The outputs AO1 and DO5 (usually connected to the device's auxiliary 12 Vdc output) cannot deliver more than 70 mA in total. Also consider any other loads connected to the same 12 Vdc auxiliary output.

If the **SKP 10** keypad is connected to the device, the current becomes 55 mA.

4.3. SERIAL PORTS

	Label	Description
Serial ports	TTL	1 TTL serial for connection to programming key (MFK / UNICARD) or Personal Computer via suitable interface module (DMI)
	RS-485	Opto-isolated RS-485 serial port (functional insulation)
	LAN	1 LAN serial port for SKP10 connection

4.3.1. Power supply

The electrical power supplies must be classified Safety Extra Low Voltage (SELV) according to IEC 61140. These electrical power sources are isolated between the input and output electrical circuits of the power supply and are separated by ground (earth), PELV systems and other SELV systems.

DANGER

GROUND RING CAUSING ELECTRIC SHOCK AND/OR EQUIPMENT MALFUNCTION

- Do not connect the connection to 0 V on the power supply/transformer powering this equipment to an external earth connection (ground).
- Do not connect the connection to 0 V or earth (ground) on the sensors and actuators connected to this device to an external ground connection.
- If necessary, use separate power supplies/transformers to power the sensors and actuators isolated from this equipment.

Failure to follow these instructions will result in death or serious injury.

In any case, if the specified voltage field is not maintained, the products may not work as intended. Use suitable safety interlocks and voltage monitoring circuits.

WARNING

RISK OF OVERHEATING AND FIRE

- Do not connect the equipment directly to line voltage.
- Only use Class 2 transformers/power supplies with SELV isolated voltage for supplying power to the equipment.

Failure to follow these instructions can result in death, serious injury, or equipment damage.

4.4. MECHANICAL TECHNICAL SPECIFICATIONS

	Description
	Terminals and connectors
Hazardous voltage	1 x 8-way high voltage male connector Use in combination with the female connector supplied
Low voltage	1 low voltage snap-on 20 way connector Use with COLV0000E0100
	1 x 4-way connector Use with COLV000042100
RS-485 serial	1 x 3-way connector Use with COLV000035100

4.5. MECHANICAL DIMENSIONS

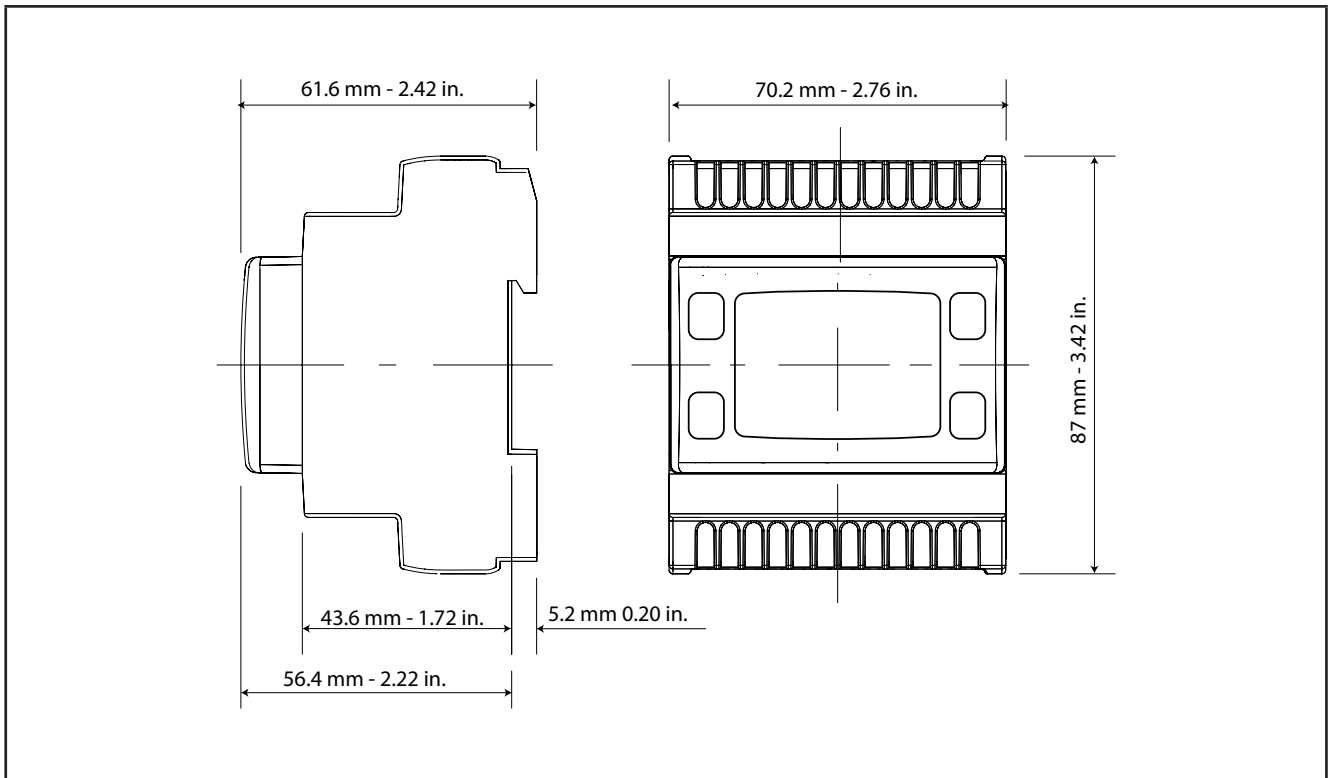

Fig. 27. EWCM 436D PRO / 455D PRO / EXP 455D PRO

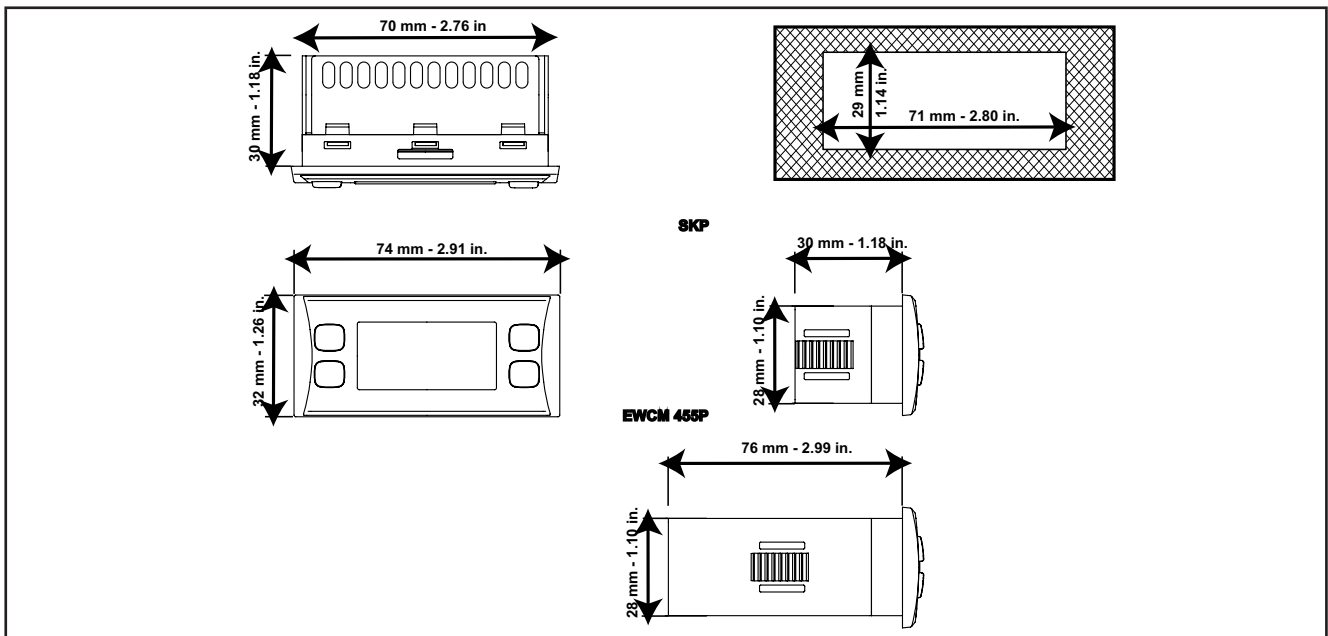

Fig. 28. EWCM 455P PRO / SKP 10

CHAPTER 5

User Interface (folder PAR/UI)

The interface, comprising the front cover of the controller, allows you to perform all operations needed to use the device.

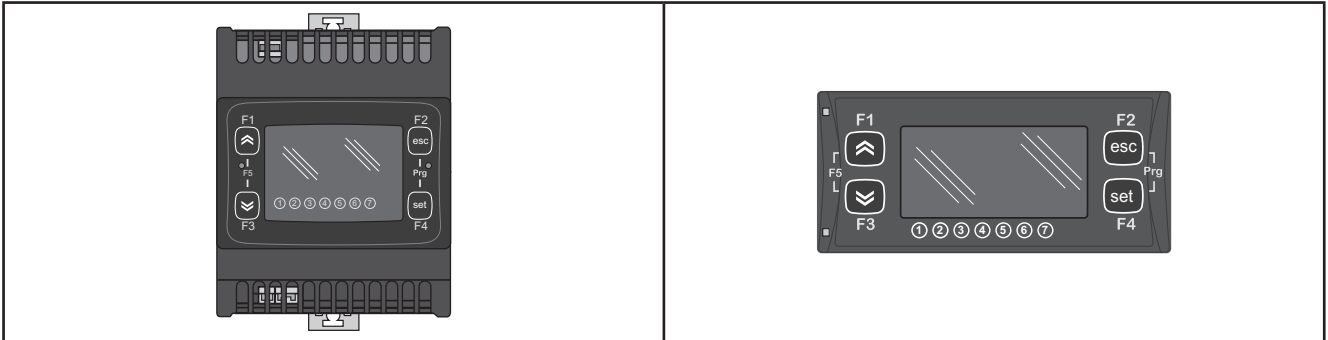

Fig. 29. EWCM 400D PRO A-STD

Fig. 30. EWCM 455P PRO A-STD

5.1. KEYS

Key	Single press (press and release)	Function key
 UP	<ul style="list-style-type: none"> Increase a value Go to next label Changes the display from suction to discharge on the main screen 	F1 Press and hold to reset the alarm log
DOWN 	<ul style="list-style-type: none"> Decrease a value Go to previous label Changes the display from suction to discharge on the main screen 	F3
esc	<ul style="list-style-type: none"> Exit without saving new settings Go back to previous level Changes the display from °C to Bar on the main screen 	F2 (*)
set	<ul style="list-style-type: none"> Confirm value / exit and save new settings Move to next level (open folder, subfolder, parameter, value) Open Status Menu 	F4
[F1+F3]	Allows switching between the main BIOS menu display and the main 400D STD application menu display and vice-versa	F5
[F2+F4]	Open programming menu	Prg

(*) The display on the main screen can also be switched between °C and bar from SKP 10 by pressing the esc key (**F2**) on the keypad for at least 3 seconds.

5.2. LEDS AND DISPLAY















The display has 18 icons (LEDs) split into 3 categories:

- Statuses and Operating Modes
- Values and Units of Measure
- Utilities

5.2.1. Display

The display shows the value/resource set for the “main display”. Values of up to 4 digits or 3 digits plus sign can be displayed.

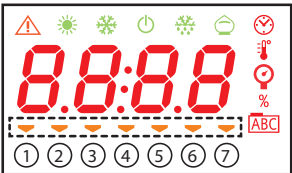
5.2.2. LEDS

Status and Operating Mode LEDS	Icons	Description	Color	
 <p>If there is an alarm, the Alarm icon lights up.</p>		Alarm	Red	
		Main display of values read by the discharge probe.	Green	
		Main display of values read by the suction probe.		
		Stand-by		
		Not used		
		Floating condensation enabled		
Unit of measure LED	Icons	Description	Color	
		Clock (RTC)	Red	
		Temperature (°C)		
		Pressure (Bar)		
		Relative humidity RH% or % of analogue output		
		Menu (ABC)		
Utilities LED	Icons	Description	Configuration	Color
		Utility	① Configured via parameter 01u	Amber yellow
			② Configured via parameter 02u	
			③ Configured via parameter 03u	
			④ Configured via parameter 04u	
			⑤ Configured via parameter 05u	
			⑥ Configured via parameter 06u	
			⑦ Configured via parameter 07u	

5.3. STARTUP

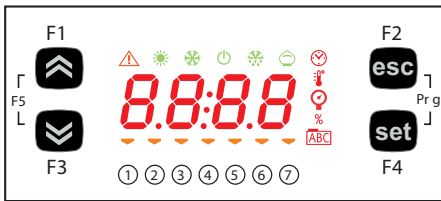

When switched on, the controller performs a lamp test to check its condition and make sure it is working properly.

The Lamp Test takes a few seconds. In this short time interval, all the LEDs and digits on the display will flash at once.

When the controller is switched on the adjustment is always active. On the main screen the device presents the suction probe value in "bar".

The user can edit the main screen; see [5.1. Keys page 39](#)

If the instrument is in stand-by it will show "OFF".

5.4. ACCESS TO FOLDERS - MENU STRUCTURE

Folders are organized into menus.

Access is defined by the keys on the front cover (see [5.1. Keys page 39](#)).

The method for accessing the different menus is described below (or in the chapters indicated).

The device has two programming menus:

- o BIOS menu, for the "native" configuration of the controller (I/O, various peripherals)
 - o Probe configuration parameters
 - o Communication parameters
 - o Input and output statuses
- o **400D STD** application menu

F1+F3: Allows switching between the BIOS menu display and the **400D STD** application menu display and vice-versa.

F2+F4: Open programming menu

5.5. BIOS MENU

EWCM 400D PRO A-STD has a BIOS menu to manage the "Status" and "Programming" menus.

5.5.1. BIOS "Status" menu

The resource values can be viewed in the status menu.

Label							Description	Edit
Ai	AiL1	AiL2	AiL3	AiL4	AiL5	AiE1	Analog inputs	/
	AiE2	AiE3	AiE4	AiE5	/	/		
di	diL1	diL2	diL3	diL4	diL5	diL6	Digital inputs	/
	diE1	diE2	diE3	diE4	diE5	diE6		
AO	tCL1	AOL1	AOL2	AOL3	AOL4	AOL5	Analog outputs	/
	AOE1	AOE2	AOE3	AOE4	AOE5	/		
dO	dOL1	dOL2	dOL3	dOL4	dOL5	dOE1	Digital outputs	/
	dOE2	dOE3	dOE4	dOE5	/	/		
CL	HOUr	dAtE	YEAR	/	/	/	Clock	Yes

Viewing Inputs/Outputs (Ai, di, AO, dO)

View Inputs/Outputs



Enter the BIOS menu by pressing the **UP+DOWN** keys

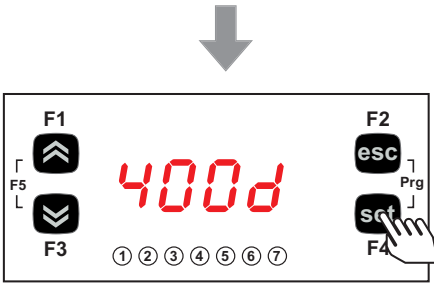

To view the inputs/outputs, from the main screen press **set**.

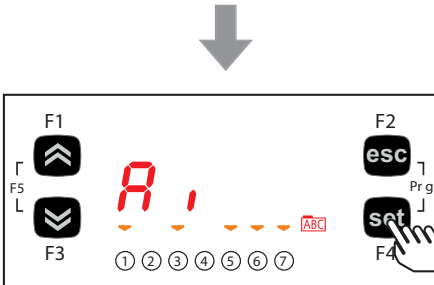

Example of Analog input display. For the other I/O* the same procedure is used**

Press **set** once to access a list of the various folders. Label Ai appears on the display.

(Use **UP** and **DOWN** to scroll through the other labels to find the one required).

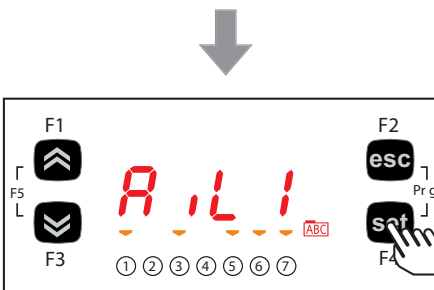

Press the **set** key to view the label for the first analog input (AiL1 in this case).

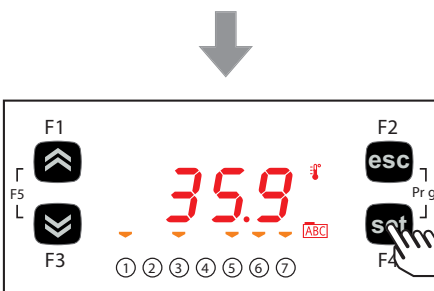

Press the **set** key again to view the value of AiL1. Note: the  icon lights up to indicate that the value shown is in degrees centigrade.

Press the **esc** key to return to the main display.

***For digital inputs / analog inputs configured as digital, the value will be:

Value	Input	For a digital input this is equivalent to	For the analog inputs configured as digital this is equivalent to
0	not active	input open	input short circuited to ground
1	active	input short circuited to ground	input open

Setting the clock (CL)

EWCM 400D PRO A-STD has a clock (RTC) used to manage the alarm log as a programmable timer thermostat. The instructions on how to set the time are given below: the same procedure can be used to edit the date and year.

Clock settings



To change the time on your machine, starting from the display, press **set**.

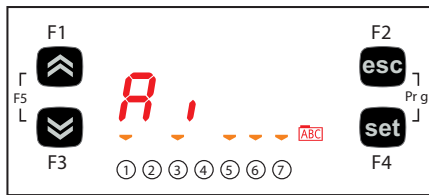

Press **set** once to access a list of the various folders. Scroll through the menu using the **UP** and **DOWN** keys until you locate the CL folder.



Press the **set** key to open the CL menu.



Once in you will see HOUr. Use **UP** and **DOWN** to set the time, date or year.

Once you have decided what you want to set, press and hold the **set** key for at least 3 seconds to enter the editing menu for the selected variable.

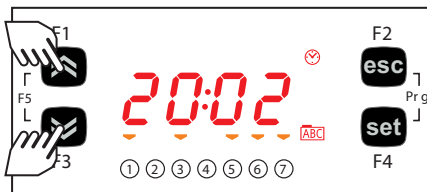

To set the time, date and year, use **UP** and **DOWN** to find the chosen value.

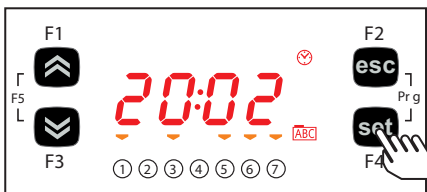

Press **set**.

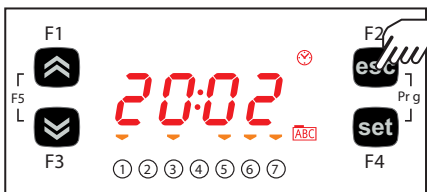

To exit the time and date settings and return to the main screen, press **esc**.

5.5.2. BIOS programming menu

Parameters	PAr	CL	CF	Ui	---
Functions	FnC	---	---	---	---
Password	PASS	---	---	---	---

Parameters (PAr folder)

The instructions on how to edit a machine parameter are given below. For example, considering the CL configuration parameter folder, parameter **CL00** (folder PAr/CL/CL00).

Editing a parameter

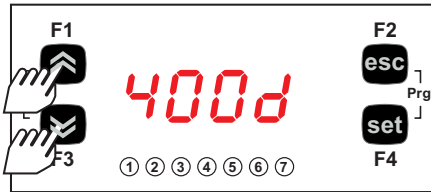

Enter the BIOS menu by pressing the **UP+DOWN** keys



To access the parameters menu, press **esc** and **set** together to enter the PAr menu.



The PAr parameters menu contains all controller parameters. Press the **set** key to view the folders.



The first folder displayed by the controller will be the CL folder. Press the **set** key again to modify individual CL parameters.

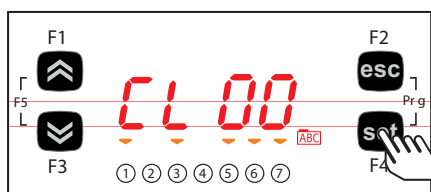

The controller will show parameter **CL00** (factory default settings).

To scroll through the various parameters press **UP** to go to the next parameter or to return to the previous one.

To view the value of the parameter press the **set** key.

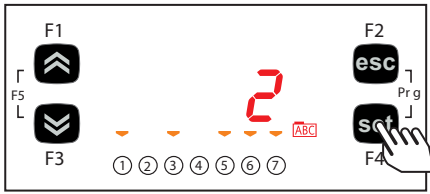

For parameter **CL00**, the value shown will be 2. Use the **UP** and **DOWN** keys to change the value.

On selecting a value, press the **set** key. **

To exit this display and return to the previous level, press the **esc** key.

N.B.: pressing the **set key confirms the modified value; pressing the **esc** key returns you to the previous level without saving the new value entered.

5.5.3. Functions (Par/FnC folder)

CC Folder

The key must be connected to the TTL serial port (See **CHAPTER 13 page 94**) and allows the rapid programming of instrument parameters.

Access the BIOS programming menu, scroll through the folders using **UP** or **DOWN** until you see the FnC folder.

Select it using **F4** (Set), scroll through the folders using **UP** or **DOWN** and select the folder using **F4** (Set) (e.g. **CC**).

Use **UP** or **DOWN** to scroll through the various available parameters (**UL**, **dL**, **Fr**) and use **F4** (Set) to select the desired parameter:

- Upload (**UL**): select **UL** and press **F4**. This function uploads the programming parameters from the instrument. If the operation is successful, the display will show **yES**, otherwise it will show **Err**.
- Format (**Fr**): This command is used to format the key.
NOTE: use of the **Fr** parameter will delete all current data. This operation cannot be reversed.
- Download (**dL**): Connect the key (see **CHAPTER 13 page 94**) when the instrument is switched off. At startup, data will automatically start downloading from the key to the instrument.
At the end of the lamp test, the display will show **yES** if the operation was successful and **Err** if it failed.

NOTE: After the Download, the instrument will use the newly uploaded map settings.

The parameters map can be downloaded when switching on the instrument (Download parameters from reset), using the same procedure described in **Chapter 13.3 page 95**.

Setting a password (Par/PASS folder)

Access the PASS folder (from the main display, by pressing both **esc** and **set** and search the folder using **UP/DOWN**). Set the PASS value to view the parameters visible for that password.

Setting the password



To view the PASS folder in the main display, press **esc** and **set** at the same time.

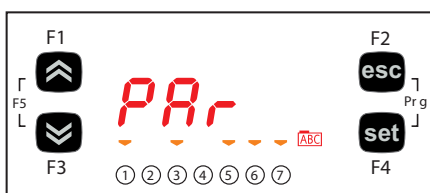

Pressing both keys will open the menu containing the list of folders. Use **UP** and **DOWN** to scroll through the list to the PASS folder.

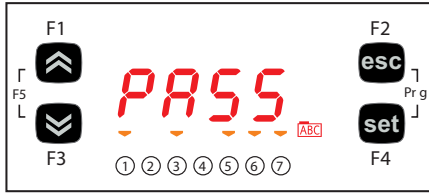

Press **set** to enter the PASS folder.
From here, set the password (installer or manufacturer), press **set** and exit.

Now open and view parameters to change a value (see [5.5.2. Bios programming menu page 45](#)).

5.6. 400D STD APPLICATION MENU

5.6.1. 400D STD Status menu

The resource values can be viewed in the “Status” menu.

Label							Description
SEt	SP1	SP2	/	/	/	/	Viewing the operating setpoints
Ai (1)	tSC	PSC	tCd	PCd	tES	tLr	Viewing the probes connected to the device
	tdS	Sb	tSH	SHt	tCr	/	
StC	Pid	UALU	StC1	HC1	dC1	StC2	Viewing compressors operating time
	HC2	dC2	StC3	HC3	dC3	StC4	
	HC4	dC4	/	/	/		
StF	StFi	PidF	nigH	StF1	HF1	dF1	Viewing fan operating status
	StF2	HF2	dF2	StF3	HF3	dF3	
	StF4	HF4	dF4	/	/	/	
rEL	idF	rEL	tAb	CrCH	CrCL	/	Viewing the device release
AL	Er01 ... Er50		/	/	/	/	Viewing active alarms

(1)

tSC = Suction Pressure Converted to Temperature Based on Configured Gas (°C)
(this is not a real temperature probe, it is the conversion of Suction Pressure)

PSC = Suction Pressure (Bar)

tCd = Condensation Pressure Converted to Temperature Based on Configured Gas (°C)
(it is not a true temperature probe it is the conversion of the Condensing Pressure)

PCd = Condensation Pressure (Bar)

tES = External Temperature (°C)

tLr = Liquid Return Temperature of the Condenser (°C)

tdS = Digital Scroll Compressor Discharge Temperature (°C)

Sb = Subcooling at Condenser Outlet (K)

(It is a calculation made with the condensing pressure converted into temperature and the liquid return temperature)

tSH = Suction Temperature (°C)

SHt = Suction Superheat (K)

(It is a calculation made with the Suction pressure converted into temperature and the Suction temperature)

tCr = Generic Temperature/Pressure Regulator

Viewing the Status menu

Viewing the "Status" menu



To view the "status" menu, from the main screen press **set**.



Press **set** once to access a list of the various folders.
Label Set appears on the display.

(Use **UP** and **DOWN** to scroll through the other labels to find the one required).



Press the **set** key to view the label for the required folder (AL in this case).

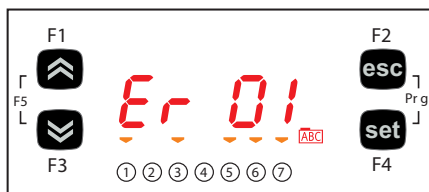

Press the **set** key again to view the value of **Er01**.
Press the **esc** key to return to the main display.

5.6.2. 400D STD Programming menu

Viewing the Programming menu

Editing a parameter



To access the parameters menu, press **esc** and **set** together to enter the PAR menu.

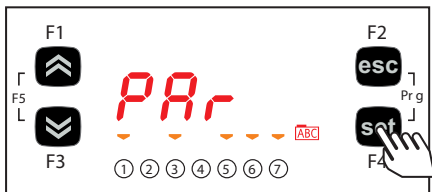

The PAR parameters menu contains all controller parameters. Press the **set** key to view the folders.

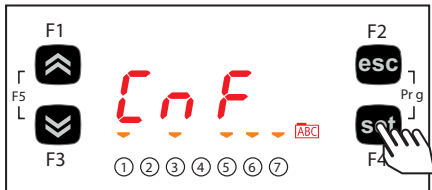

The first folder the controller shows is the CnF configuration folder. Press the **set** key again to modify individual CL parameters.



The controller will show parameter **Ert** (default settings).

To scroll through the various parameters press **UP** to go to the next parameter or **DOWN** to return to the previous one.

To view the value of the parameter press the **set** key.

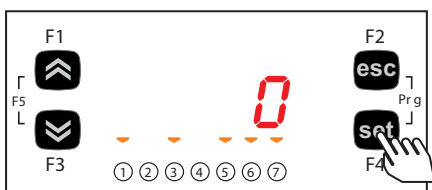

For parameter **Ert**, the set value shown will be 0. Use the **UP** and **DOWN** keys to change the value.

On selecting a value, press the **set**** key.

To exit this display and return to the previous level, press the **esc** key.

****Note:** pressing the **set** key confirms the modified value; pressing **esc** returns to the previous level without modifying the set value.

CHAPTER 6

Physical I/O configuration (PAR/CL..CE folder)

The application of incorrect current or voltage values at the analog inputs and outputs could damage the electronic circuits. Moreover, connection of a current input device to an analog input configured for voltage and vice-versa will also damage the electronic circuits.

NOTICE

INOPERABLE DEVICE

- Do not apply voltages over 11 Vdc to the analog inputs on the controller or the input/output expansion module when the analog input is configured as a 0-10 V input.
- Do not apply currents over 30 mA to the analog inputs on the controller or the input/output expansion module when the analog input is configured as a 0-20 mA or 4-20 mA input.
- Make sure that the signal applied corresponds to the analog input configuration.

Failure to follow these instructions can result in equipment damage.

6.1. CONTROLLER ANALOG INPUTS

There are a total of 5 analog inputs on the controllers, referred to below as **AiL1...AiL5**.

Using the parameters, a physical resource (probe, digital input, voltage/current signal) can be “physically” configured for each type of input:

- 3 inputs can be configured as temperature probes (NTC type probe) or as digital inputs.
- 2 inputs (AiL3 and AiL4) can be configured as temperature probes, an NTC type probe, as digital inputs or current/voltage input (signal 0...20 mA / 4...20 mA / 0...10 V, 0...5 V, 0...1 V).

Par.	Description	0	1	2	3	4	5	6	7	8
CL00	Analog input AiL1 type	Probe not configured	Reserved	NTC sensor	/	/	/	/	/	/
CL01	Analog input AiL2 type	Probe not configured	Reserved	NTC sensor	/	/	/	/	/	/
CL02	Analog input AiL3 type	Probe not configured	Reserved	NTC sensor	4...20 mA	0...10 V	0...5 V	0...1 V	0...20 mA	/
CL03	Analog input AiL4 type	Probe not configured	Reserved	NTC sensor	4...20 mA	0...10 V	0...5 V	0...1 V	0...20 mA	/
CL04	Analog input AiL5 type	Probe not configured	Reserved	NTC sensor	/	/	/	/	/	/

Parameter	AI analog input	Range	Description
CL10	AiL3	CL11...999.9	Analog input AiL3 fullscale value
CL11	AiL3	-999.9...CL10	Analog input AiL3 start of scale value
CL12	AiL4	CL13...999.9	Analog input AiL4 fullscale value
CL13	AiL4	-999.9...CL12	Analog input AiL4 start of scale value

For the analog input used as a suction pressure sensor, multiply the start and end values of the scale by 10 (high resolution)

Parameter	Description	Unit of measure	Range
CL20	Analog input AiL1 differential	°C	-12.0..12.0
CL21	Analog input AiL2 differential	°C	-12.0..12.0
CL22	Analog input AiL3 differential	°C / Bar	-12.0..12.0
CL23	Analog input AiL4 differential	°C / Bar	-12.0..12.0
CL24	Analog input AiL5 differential	°C	-12.0..12.0

For the analog input used as a suction pressure sensor, multiply the offset (calibration) value by 10 (high resolution)

6.2. EXPANSION ANALOG INPUTS

There are a total of 5 analog inputs on the expansion device, referred to below as **AiE1...AiE5**.

Using the parameters, a physical resource (probe, digital input, voltage/current signal) can be “physically” configured for each type of input:

- 3 inputs can be configured as temperature probes (NTC type probe) or as digital inputs.
- 2 inputs (AiE3 and AiE4) can be configured as temperature probes, an NTC type probe, as digital inputs or current/voltage input (signal 0...20 mA / 4...20 mA / 0...10 V, 0...5 V, 0...1 V).

Par.	Description	0	1	2	3	4	5
CE00	Analog input AiE1 type	Probe not configured	Reserved	NTC sensor	/	/	/
CE01	Analog input AiE2 type	Probe not configured	Reserved	NTC sensor	/	/	/
CE02	Analog input AiE3 type	Probe not configured	Reserved	NTC sensor	4...20 mA	0...10 V	0...5 V
CE03	Analog input AiE4 type	Probe not configured	Reserved	NTC sensor	4...20 mA	0...10 V	0...5 V
CE04	Analog input AiE5 type	Probe not configured	Reserved	NTC sensor	/	/	/

Parameter	AI analog input	Range	Description
CE10	AiLE	CL11 ...999.9	Analog input AiL3 fullscale value
CE11	AiLE	-999.9... CL10	Analog input AiL3 start of scale value
CE12	AiLE	CL13 ...999.9	Analog input AiL4 fullscale value
CE13	AiLE	-999.9... CL12	Analog input AiL4 start of scale value

For the analog input used as a suction pressure sensor, multiply the start and end values of the scale by 10 (high resolution)

Parameter	Description	Unit of measure	Range
CE20	Analog input AiE1 differential	°C	-12.0..12.0
CE21	Analog input AiE2 differential	°C	-12.0..12.0
CE22	Analog input AiE3 differential	°C / Bar	-12.0..12.0
CE23	Analog input AiE4 differential	°C / Bar	-12.0..12.0
CE24	Analog input AiE5 differential	°C	-12.0..12.0

For the analog input used as a suction pressure sensor, multiply the offset (calibration) value by 10 (high resolution)

6.3. DIGITAL INPUTS

There are 6 voltage-free digital inputs, identified below as D11...D16; these cannot be configured.

6.4. DIGITAL OUTPUTS

See **CHAPTER 3 Electrical connections page 19** for the number and capacity of the relays/open collectors used and for information regarding the symbols used on labels supplied with the instrument.

- Hazardous voltage outputs, relay.
- Low voltage (SELV) outputs, open collector.

The digital outputs are identified as DO1 ... DO6 and cannot be configured.

6.5. ANALOG OUTPUTS

See **CHAPTER 3 Electrical connections page 19** for the number and type of analog outputs used and for information on the symbols used on labels supplied with the controller.

There are 6 analog outputs: hazardous voltage output(s) and low voltage (SELV) output(s), the exact number of which depends on the version and the characteristics, as specified below:

EWCM 436D PRO STD analog outputs

Output	Label on display	Hazardous voltage	(SELV)		
			Open Collector PWM/PPM	0...10 V	0...20 mA 4...20 mA
TC1	TCL1	2 A 240 Vac	/	/	/
TC2	AOL2	2 A 240 Vac	/	/	/
AO1	AOL1	/	●	/	/
AO3	AOL3	/	/	●	/
AO4	AOL4	/	/	●	/
AO5	AOL5	/	/	/	●

DO6 configures output TC1

AO2 configures output TC2

Triac analog outputs (TC1, TC2)

The high voltage TRIAC outputs are used to control the coil on the Digital Scroll compressor.

The TRIAC outputs, when partialized, suppress the half-wave at the zero-crossing.

Analog output SELV AO5		
Parameter	Description	Values
CL60 (EWCM 436D PRO only)	AOL5 type analogue output	0= 0...20 mA Current analog output on dedicated version 1= 4...20 mA Current analog output on dedicated version 2= Reserved.

EWCM 455D PRO STD / 455P PRO STD / EXP 455D PRO analog outputs

Output	Label on display	(SELV)		
		Open Collector PWM/PPM	0...10 V	0...20 mA 4...20 mA
AO1	AOL1	●	/	/
AO2	AOL2	●	/	/
AO3	AOL3	/	●	/
AO4	AOL4	/	●	/
AO5	AOL5	/	●	/

The following can be piloted:

- Loads with output modulation or
- Loads with on/off type switching using
 - o the output as 0...10 V switch (AO3-4).
 - o the output as 0...10 V or 4...20 mA / 0...20 mA (AO5) switch (4...20 mA / 0...20 mA for **EWCM 436D PRO** only).

⚠ WARNING

UNINTENDED EQUIPMENT OPERATION

Do not install contactors or other interposition relays downstream from the Triac outputs.

Failure to follow these instructions can result in death, serious injury, or equipment damage.

CHAPTER 7

Device configuration (PAR/CnF...LEd folder)

The **EWCM 400D PRO A-STD** controllers are programmed to manage digital scroll or inverter compressor racks. Digital Scroll compressor regulation takes place via the TRIAC TC1 output.

NOTICE

INOPERABLE DEVICE

Power the EWCM 436D PRO only with an alternating current.

Failure to follow these instructions can result in equipment damage.

In addition to controlling the Digital Scroll/Inverter compressor, the **EWCM 400D PRO A-STD** control is able to control up to 3

On / Off compressors with up to 4 steps for each. Alternatively, up to 4 ON/OFF compressors with up to 4 steps each can be configured. Condensation control can take place by means of 4 ON/OFF fans or by means of an inverter-driven fan.

7.1. DEVICE CONFIGURATION PARAMETERS

In the folder **CnF** it is possible to configure:

- Select refrigerant type;
- Select number of compressors and compressor steps;
- Select number of compressors on if there is a suction probe error;
- Select power supplied by the modulating compressor in the event of a suction probe error;
- Select number of digital and analog fans;
- Enable temperature probes;
- Enable expansion device.

7.1.1. Type of refrigerant

The type of refrigerant used in the system can be configured by setting the **Ert** parameter:

Parameter	Description	Values
Ert	Select type of refrigerant	0 = R404A; 1 = R22; 2 = R744; 3 = Reserved; 4 = R134a; 5 = R407C; 6 = R410A; 7 = R427A; 8 = R507A; 9 = R407A; 10 = R717; 11 = R407F; 12 = R450 (liquid); 13 = R448A; 14 = R448A (gas); 15 = R513A; 16 = R449A (liquid); 17 = R449 (gas).

7.1.2. Compressor type and number of steps

Parameters **Ct1...Ct4** can be used to select the type of compressor managed by the **EWCM 400D PRO A-STD** controller, as well as the number of steps for each compressor via parameters **nS1...nS4**.

Parameter	Description	Values
Ct1...Ct4	Compressor type 1...4	0 = Disabled; 1 = Semi-hermetic; 2 = Standard; 3 = Screw; 4 = Inverter (compressor 1 - Ct1 only); 5 = Digital Scroll (compressor 1 - Ct1 only);
nS1...nS4	Number of compressor steps 1...4 (valid if Ct1...Ct4 ≤ 3)	1 = 1 step; 2 = 2 steps; 3 = 3 steps; 4 = 4 steps.

Percentage of power supplied with probe error

It is possible to configure the percentage of power supplied by the compressor in the event that the suction probe is experiencing an error, by means of parameter **CPE**.

Parameter	Description	Values
CPE	Number of active steps in the event of a probe fault	0 ... 16
CPi	Percentage of power supplied by the Inverter/DGS compressor in the event of a probe error	CPPm 100%

7.1.3. Managing the digital and analog fans

The **EWCM 400D PRO A-STD** controller can manage up to 4 digital outputs to manage the digital fans and up to one analog output to control the EC fans via the inverter.

Parameter	Description	Values
nFn	Number of digital fans	0 = No digital output configured for fan control; 1 = 1 digital output configured for fan control; 2 = 2 digital outputs configured for fan control. 3 = 3 digital outputs configured for fan control; 4 = 4 digital outputs configured for fan control.
nFA	Number of analog fans	0 = No analog output configured for Inverter control; 1 = 1 analog output configured for Inverter control.

7.1.4. Temperature probe enabling

The **EWCM 400D PRO A-STD** controller can manage up to 4 analog inputs for managing machine alarms and floating condensation. They are enabled by the parameters:

Parameter	Description	Values
FtE	Enable discharge probe.	OFF = disabled; On = enabled.
CtE	Enable suction probe.	
EeT	Enable external temperature probe.	
ELr	Enable liquid return temperature probe.	
EnEp	Enable expansion device.	

7.2. I/O CONFIGURATION PARAMETERS

7.2.1. Configuration of analog inputs

The **EWCM 400D PRO A-STD** controller can manage 10 analog inputs (5 analog inputs on the controller + 5 analog inputs on the expansion device), which can be configured using the parameters:

Parameter	Description	Value
01P	AI1 (Controller)	0 = Disabled; 1 = Suction pressure (Compressor regulation probe) (configured Controller current inputs); 2 = Discharge pressure (Fan regulation probe) (configured Controller current inputs); 3 = External temperature; 4 = Liquid return temperature; 5 = Discharge temperature; 6 = Suction temperature (calculate superheat); 7 = General regulator temperature
02P	AI2 (Controller)	
03P	AI3 (Controller)	
04P	AI4 (Controller)	
05P	AI5 (Controller)	
11P	AIE1 (Expansion)	
12P	AIE2 (Expansion)	
13P	AIE3 (Expansion)	
14P	AIE4 (Expansion)	
15P	AIE5 (Expansion)	

7.2.2. Configuration of analog outputs

The **EWCM 400D PRO A-STD** controller can manage 10 analog outputs (5 analog outputs managed by the controller + 5 analog inputs managed by the expansion device).

Parameter	Description	Value
01n	AO1 (Controller)	0 = Disabled; ±2 = Digital Fan 2; ±4 = Digital Fan 4; ±6 = CP1 Step 1 drive; ±8 = CP1 Step 3 drive; ±10 = CP2 Step 1 drive; ±12 = CP2 Step 3 drive; ±14 = CP3 Step 1 drive; ±16 = CP3 Step 3 drive; ±18 = CP4 Step 1 drive; ±20 = CP4 Step 3 drive; ±22 = Inverter Fan drive; ±24 = Night Mode active; 26 = Compressor Inverter (AO3...AO5 only); 28 = General regulator analog output (AO3...AO5 only); - The + sign indicates that the output is active when the contact is closed. - The - sign indicates that the output is active when the contact is open. NOTE: For values ±1 ... ± 25, the outputs will act as On/Off.
02n	AO2 (Controller)	
03n	AO3 (Controller)	
04n	AO4 (Controller)	
05n	AO5 (Controller)	
11n	AOE1 (Expansion)	
12n	AOE2 (Expansion)	
13n	AOE3 (Expansion)	
14n	AOE4 (Expansion)	
15n	AOE5 (Expansion)	

NOTE: TC2 is configured via parameters **02n**.

7.2.3. Configuration of digital inputs

The **EWCM 400D PRO A-STD** controller has 12 digital inputs (6 digital inputs managed from the controller + 6 digital inputs managed from the expansion device), which can be configured via parameters:

Parameter	Description	Value
i01	di1 (Controller)	0 = Disabled; ±2 = Compressor 2 thermal switch; ±4 = Compressor 4 thermal switch; ±6 = Fan 2 thermal switch; ±8 = Fan 4 thermal switch; ±10 = High pressure switch; ±12 = Fan Inverter Thermal switch; ±14 = Enable reduced discharge set; ±16 = Enable floating condensation; ±18 = Night mode; - The "+" sign indicates that the input is active when the contact is closed. - The "-" sign indicates that the input is active when the contact is open.
i02	di2 (Controller)	
i03	di3 (Controller)	
i04	di4 (Controller)	
i05	di5 (Controller)	
i06	di6 (Controller)	
i07	diE1 (Expansion)	
i08	diE2 (Expansion)	
i09	diE3 (Expansion)	
i10	diE4 (Expansion)	
i11	diE5 (Expansion)	
i112	diE6 (Expansion)	

7.2.4. Digital output configuration

The **EWCM 400D PRO A-STD** controller has 12 digital outputs (6 digital outputs managed from the controller + 6 digital outputs managed from the expansion device), which can be configured via parameters:

Parameter	Description	Value
d01	DO1 (Controller)	0 = Disabled; ±2 = Digital Fan 2; ±4 = Digital Fan 4; ±6 = CP1 Step 1 drive; ±8 = CP1 Step 3 drive; ±10 = CP2 Step 1 drive; ±12 = CP2 Step 3 drive; ±14 = CP3 Step 1 drive; ±16 = CP3 Step 3 drive; ±18 = CP4 Step 1 drive; ±20 = CP4 Step 3 drive; ±22 = Inverter Fan drive; ±24 = Night Mode; - The "+" sign indicates that the input is active when the contact is closed. - The "-" sign indicates that the input is active when the contact is open.
d02	DO2 (Controller)	
d03	DO3 (Controller)	
d04	DO4 (Controller)	
d05	DO5 (Controller)	
d06	DO6 (Controller)	
d11	DOE1 (Expansion)	
d12	DOE2 (Expansion)	
d13	DOE3 (Expansion)	
d14	DOE4 (Expansion)	
d15	DOE5 (Expansion)	
d16	DOE6 (Expansion)	

7.2.5. LED configuration

The LEDs on the display can be configured via the parameters, in the LED folder.

Parameter	Description	Value
O1u	Configuration of LED 1	0 = Disabled; 2 = Digital Fan 2; 4 = Digital Fan 4; 6 = Compressor 2 drive; 8 = Compressor 4 drive; 10 = Inverter Fan drive; 12 = CP1 Step 2 drive; 14 = CP2 Step 1 drive; 16 = CP2 Step 3 drive; 18 = CP3 Step 2 drive; 20 = CP4 Step 1 drive; 22 = CP4 Step 3 drive;
O2u	LED 2 configuration	
O3u	LED 3 configuration	
O4u	LED 4 configuration	
O5u	LED 5 configuration	
O6u	LED 6 configuration	
O7u	LED 7 configuration	

CHAPTER 8

Compressors

The **EWCM 400D PRO A-STD** controller bases its regulation on the suction pressure. It is possible to reset the running time in the PRG programming menu, in the rSt folder.

8.1. TYPE OF COMPRESSORS SUPPORTED

The **EWCM 400D PRO A-STD** controller can manage between 0 and 4 compressors at once (see parameters **Ct1...Ct4**).

Parameter	Description	Values
Ct1...Ct4	Compressor type 1...4	0 = Disabled; 1 = Semi-hermetic; 2 = Standard; 3 = Screw; 4 = Inverter (compressor 1 - Ct1 only); 5 = Digital Scroll (compressor 1 - Ct1 only);
nS1...nS4	Number of compressor steps 1...4 (valid if Ct1...Ct4 < 3)	1 = 1 step; 2 = 2 steps; 3 = 3 steps; 4 = 4 steps.

Valve connection

The data provided in the following table is presented in conformity with Copeland technical documentation. Manufacturer specifications are subject to change without notice.

	COPELAND Coil ID	COPELAND Valve body ID
Kit 1	023-0060-00 / 20160927 Coil AC 220V 50/60Hz	010-0082-00 / 170313 Valve R410A
Kit 2	023-0104-02 / V1531 Coil AC 200-240V 50/60Hz Coil Type DRM8X	010-0182-00 / V1531 Solenoid Valve & Gasket Valve type 729RC

8.1.1. SYSTEM CONFIGURATIONS SUPPORTED

The following types of suction systems can be used:

1. No compressor. Parameter **Ct1=Ct2=Ct3=Ct4=0**
2. One single compressor. Parameter **Ct1>0** and **Ct2=Ct3=Ct4=0**
3. More than one compressor. Compressor selection must be carried out in order; if there are 3 compressors, parameter **Ct4** must be =0.

Compressor 1

Description	Ct1	nS1
No compressor	0	1
One compressor without steps (0%-100%)	1, 2, 3	1
One compressor with 2 steps (0%-50%-100%)	1, 2, 3	2
One compressor with 3 steps (0%-33%-66%-100%)	1, 2, 3	3
One compressor with 4 steps (0%-25%-50%-75%-100%)	1, 2, 3	4
One inverter compressor	4	1
One Digital Scroll compressor	5	1

Compressor 2, 3 and 4

Description	Ct2...Ct4	nS2...nS4
No compressor	0	1
One compressor without steps (0%-100%)	1, 2, 3	1
One compressor with 2 steps (0%-50%-100%)	1, 2, 3	2
One compressor with 3 steps (0%-33%-66%-100%)	1, 2, 3	3
One compressor with 4 steps (0%-25%-50%-75%-100%)	1, 2, 3	4

8.1.2. Compressor partialization management

Power (%)	Ct1...Ct4 = 1				Ct1...Ct4 = 2				Ct1...Ct4 = 3			
	Compressor Startup	Partialization			Compressor Startup	Partialization			Compressor Startup	Partialization		
		1	2	3		1	2	3		1	2	3
100	ON	/	/	/	ON	ON	ON	ON	ON	/	/	/
75	ON	/	/	ON	ON	ON	ON	/	ON	/	/	ON
50	ON	/	ON	ON	ON	ON	/	/	ON	/	ON	/
25	ON	ON	ON	ON	ON	/	/	/	ON	ON	/	/
0	OFF	/	/	/	OFF	/	/	/	OFF	/	/	/

8.2. COMPRESSOR REGULATION

Compressor regulation may take place in 2 ways and can be configured via parameter **CCFn**:

1. **CCFn** = On; proportional band regulation;
2. **CCFn** = OFF; neutral zone regulation.

8.2.1. Proportional band regulation

The power required by the suction regulator (number of resources) is proportional to the difference between setpoint **SP1** and the suction regulation probe.

The pressure interval between the activation of one step and another depends on the proportional band **CBn** and the number of steps used. The number of resources is set by the number of compressors and the number of steps for each compressor.

Power increase and decrease times are managed via parameters **CdOn** and **CdOf**. For a power increase or decrease to take place, the pressure must satisfy the condition for a time period equal to **CdOn** or **CdOf** respectively.

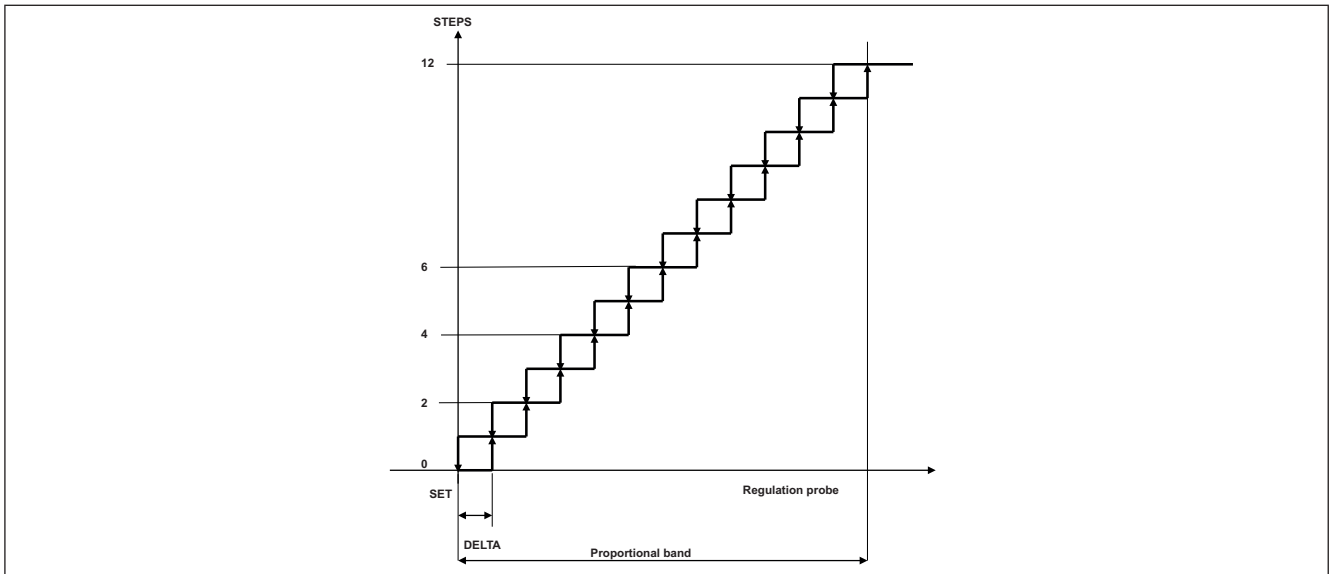

Fig. 31. Division of the proportional band with ON/OFF and stepped compressors

Proportional band with modulating compressor

If the site also has an Inverter or Digital Scroll compressor, the management of standard compressors remains the same as indicated in chapter 8.2.1. [Proportional band regulation page 59](#).

To move up a step, you must wait for the modulating compressor is at 100% of its modulation, while to move down a step the modulating compressor must reach the minimum power as set by parameter **CPPm**. The modulating compressor will always be the first to switch on and the last to switch off.

The modulating compressor can work in two different ways, depending on the value of parameter **CAP**.

If CAP = OFF

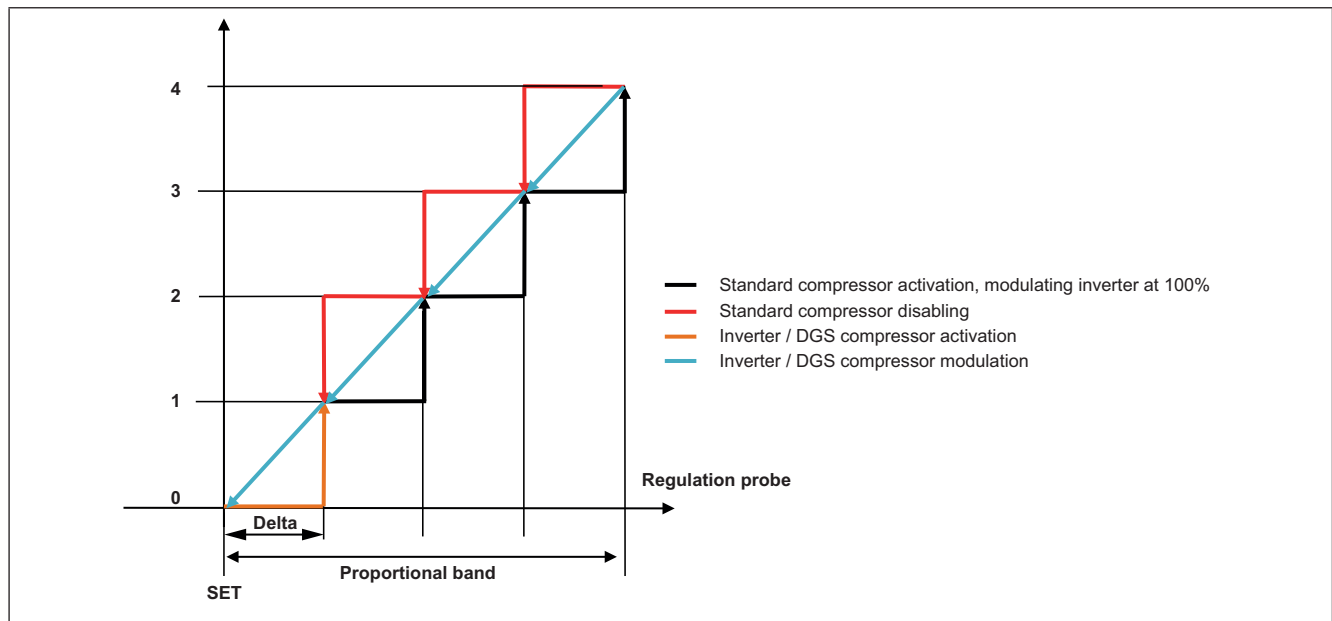

Fig. 32. Proportional band regulation with Inverter / Digital Scroll compressor

The modulating compressor is activated at the value of **SEt** + Delta (orange line) and remains at maximum power until **Set** + 2*Delta, at which point the 1st power step will be activated. If the pressure drops, the modulating compressor will begin to modulate proportionally within the band **SEt** + Delta, **SEt** + 2*Delta (blue line). If the pressure drops to values < **SEt** + Delta, one power step will be deactivated and the modulating compressor will begin to modulate proportionally within the band **Set**, **Set**+Delta. The modulating compressor switches off when the pressure reaches the **SEt**.

If CAP = On

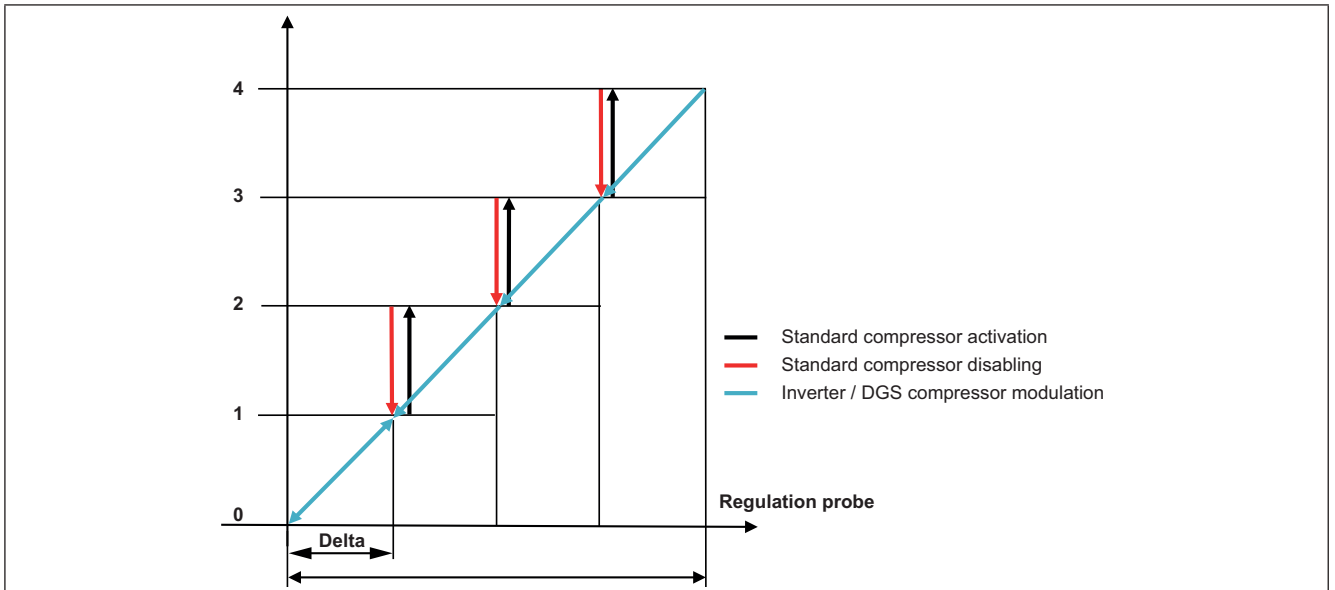

Fig. 33. Proportional band regulation with modulating compressor

The modulating compressor modulates throughout the band range.

The modulating compressor activates at pressure values > **SEt**.

When **SEt** + Delta is reached, the 1st power step will be activated. If the pressure drops, the modulating compressor will begin to modulate proportionally within the band **SEt**, **SEt** + Delta (blue line). The modulating compressor switches off when the pressure reaches the **SEt**.

8.2.2. Regulation in neutral area without modulating compressor

If the system only uses stepped compressors, the power step activation or deactivation logic is as follows:

- If the value read by the regulation probe is above the threshold **bH** or below the threshold **bL**, a counter in seconds will be activated to record the time period for which the pressure remains outside the neutral area; this counter will be reset and stopped as soon as the pressure returns to a value within the neutral area (**SEt+bL** < Pressure < **SEt+bH**).
- When the pressure remains outside the neutral area for a time period greater than the value set by the power increase/decrease time threshold, the controller requires the power level of the compressors to increase or decrease by one step. Once the step is activated or deactivated, the counter will be reset and when the time threshold is exceeded a further increase or decrease in power will be requested. The procedure will be repeated until the pressure remains outside the neutral zone and there are still power steps available. There is a time threshold corresponding to each pressure threshold:

Pressure threshold	Power increase/decrease time threshold
SEt+bH < Pressure < SEt+bHo	dH
Pressure ≥ SEt+bHo	dHo
SEt-bLo < Pressure < SEt-bL	dL
Pressure ≤ SEt-bLo	dLo

The compressor switch-on logic is based on the running time (the compressor with the lowest running time will have greater priority), while the first compressor to switch off it the first compressor that switched on.

8.2.3. Regulation in neutral area with modulating compressor

In neutral area regulation the modulating compressor is the first compressor to switch on and the last to switch off.

The modulating compressor, when on, modulates within the neutral area (**SEt-bL: SEt+bH**) with the aim of maintaining the pressure at the specified Setpoint. When the pressure is greater than the threshold **SEt+bH** the modulating compressor supplies 100% of the power, when it is below the threshold **SEt-bL** it supplies the minimum power set in parameter **CPPm**.

If the value read by the regulation probe exceeds the threshold **SEt+bH** the power steps will be activated as described in the previous chapter. If parameter **InSH** <>0, when the power step is activated the modulating compressor is forced to operate at its minimum power (parameter **CPPm**) for a time period in seconds as set in parameter **InSH**, at the end of which the modulating compressor reverts to normal modulation. This sequence repeats every time a new power step is activated.

If parameter **InSH** = 0, when a power step is activated the modulating compressor does not adjust the power it supplies.

If the value read by the regulation probe drops under the threshold **SEt-bL** the power steps will be deactivated as described in the previous chapter.

If parameter **InSL** <>0, when the power step is deactivated the modulating compressor is forced to operate at its maximum power (100%) for a time period in seconds as set in parameter **InSL**, at the end of which the modulating compressor reverts to normal modulation. This sequence repeats every time a new power step is deactivated.

If parameter **InSL** = 0, when a power step is deactivated the modulating compressor does not adjust the power it supplies.

When only the modulating compressor remains active and the pressure continues to be lower than the threshold **SEt-bL** for a sufficient time period (**dL** or **dLo**), the modulating compressor will also be deactivated.

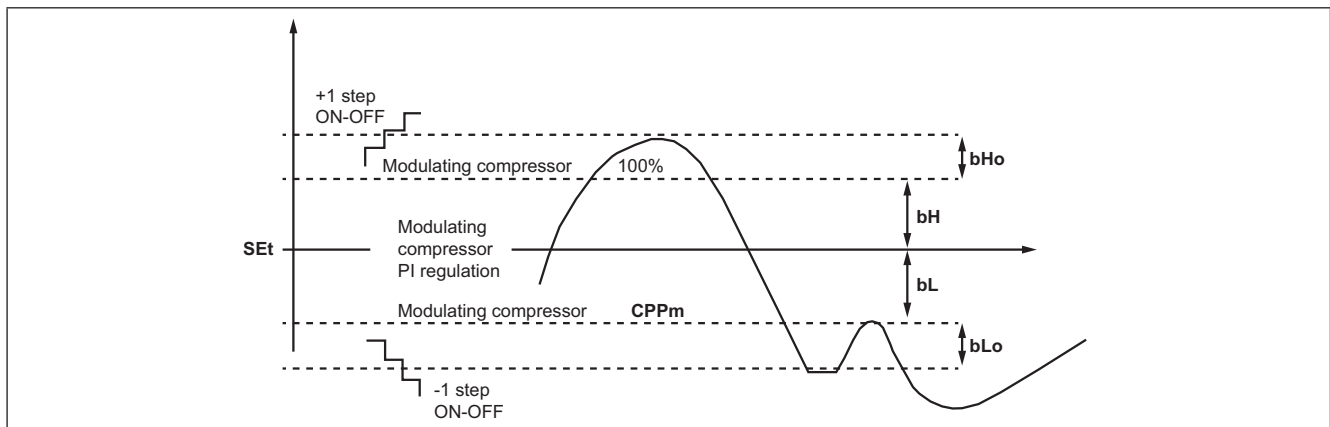

Fig. 34. Neutral area

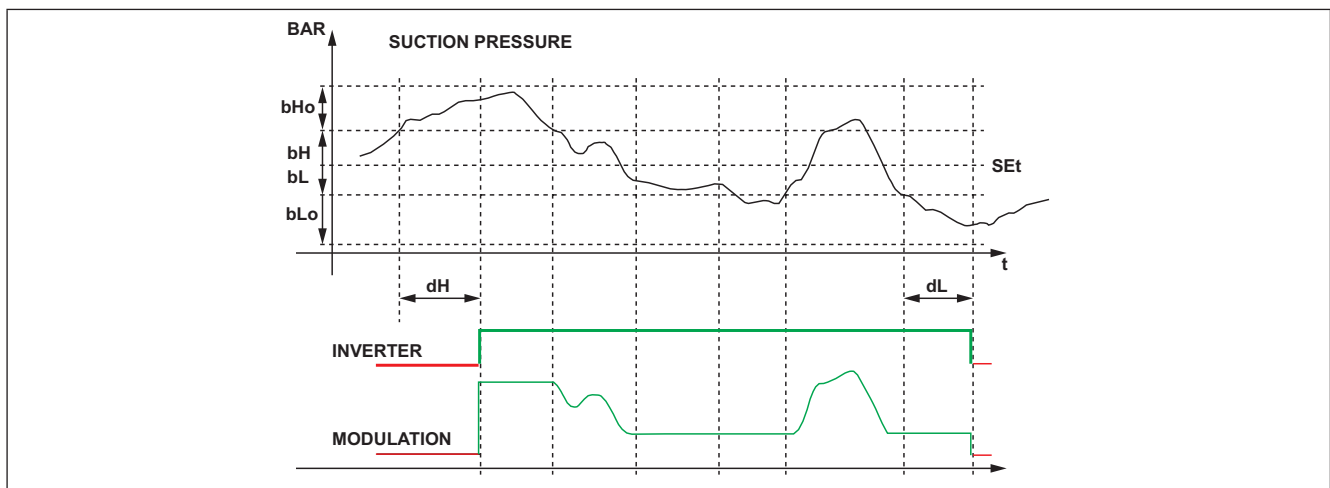

Fig. 35. Modulating compressor activation/deactivation

CHAPTER 9

Fans (FAn)

The **EWCM 400D PRO A-STD** controller bases its regulation on the condensation pressure.

9.1. SYSTEM CONFIGURATIONS SUPPORTED

The **EWCM 400D PRO A-STD** controller can manage:

- 4 digital fans;
- Analog output controlled by PID.

The parameters defining this type of control are:

Parameter	Description
nFn	Number of digital fans
nFA	Number of analog fans

Only one of the two parameters must be $\neq 0$, depending on the system type.

To disable fan management, set both parameters = 0.

9.1.1. Digital fans

Control by a proportional range is positioned on the side compared to the control setpoint.

The range is divided according to the number of fans. If there are 2 fans the proportional band is divided into 2 and at each step a fan is switched on (see Fig. 36).

When the condensation pressure is below the **SET**, all fans are off; when it is above the **SET+Proportional band** all fans are on. The startup of every fan must observe the startup delay time **Fdn**.

The switch-off of every fan must observe the switch-off delay time **FdF**.

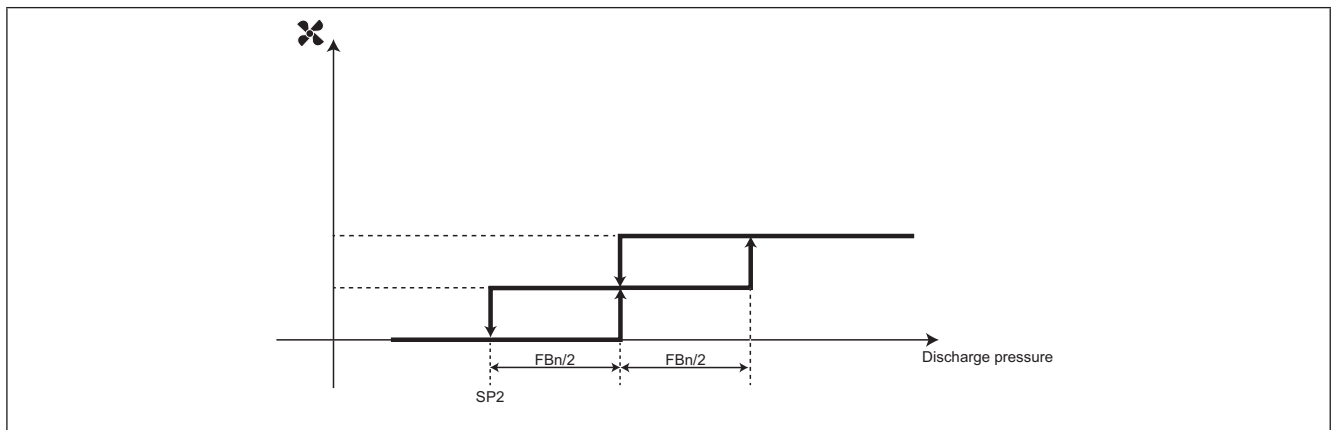

Fig. 36. Enabling the digital fans

9.1.2. Analog fan

The analog output managing the condensation is controlled by a PID controller, configured by default as only proportional, with a neutral area of 0.2 Bar.

It is possible to configure a minimum value for the analog output via the parameter **LLP**. If **LLP** \neq 0 and the output value from the PID is less than **LLP** but more than 0, then the PID is forced to have an output value of **LLP**.

The maximum value of the analog output is limited by means of parameter **HLP**, if night mode is enabled the maximum value of the output is limited by means of the value of parameter **HLn**.

If the condensation pressure exceeds the limit set by parameter **MLP**, the output will be at 100% of its power.

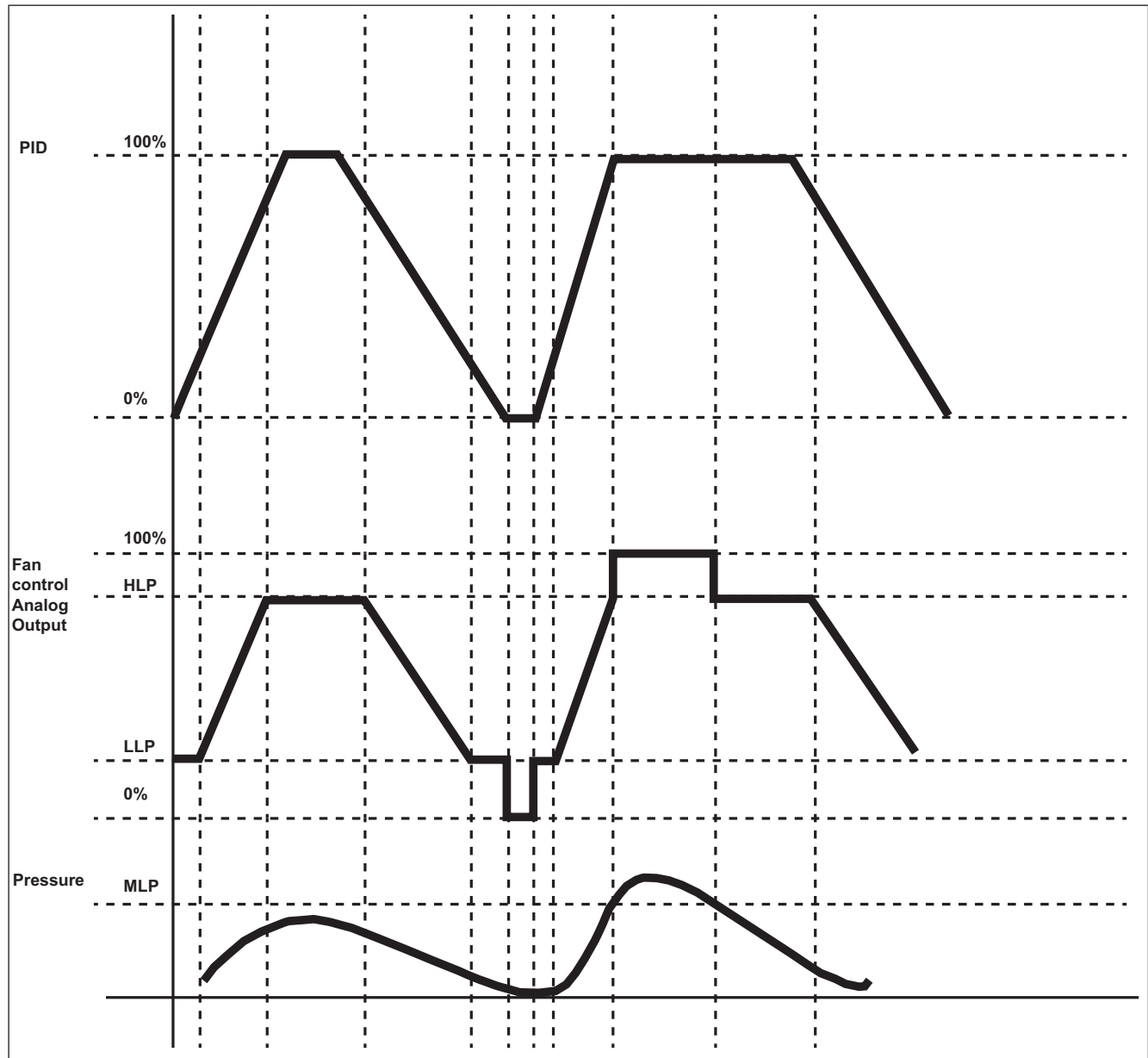

Fig. 37. Enabling the analog fans

Night Mode

Night mode for the fans may be activated on the basis of time or via a digital input, by setting parameter **nhE**:

- **nhE = OFF**, night mode is enabled via a suitably configured digital input;
- **nhE = On**, night mode is enabled via RTC. **Non** = start time; **NoF** = end time.

When the mode is active, the analog output for condenser fan management never exceeds the value set by parameter **HLn**. In each case, if the condensation pressure exceeds the limit set by parameter **MLP**, the output will be brought to 100% of its power.

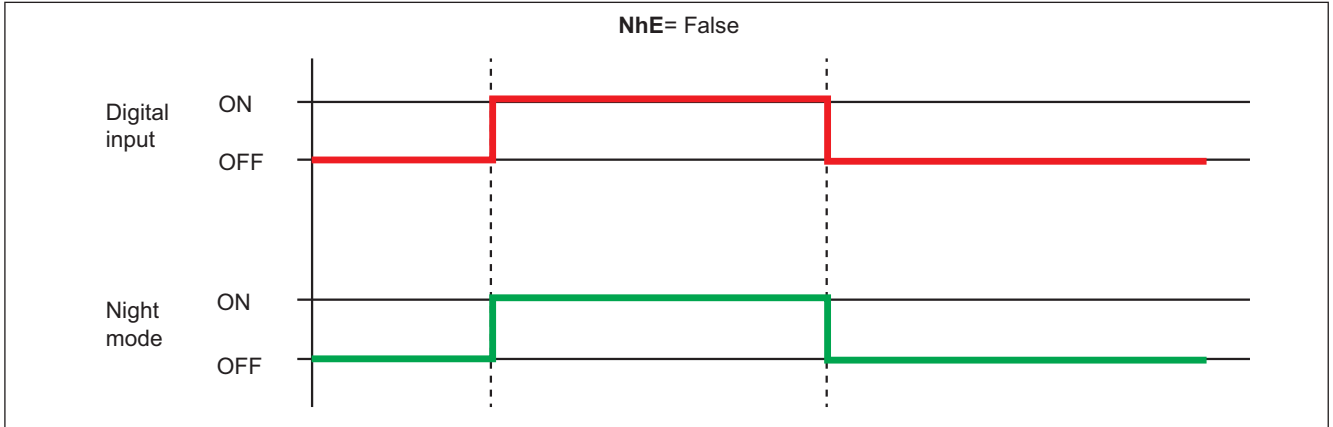

Fig. 38. Night mode activation

9.2. FLOATING CONDENSATION

9.2.1. Functioning conditions

Enabling the function via **EdC = On**.

External temperature is less than the parameter **Het**.

The condensation setpoint is calculated by adding the external temperature to the parameter **dtC**.

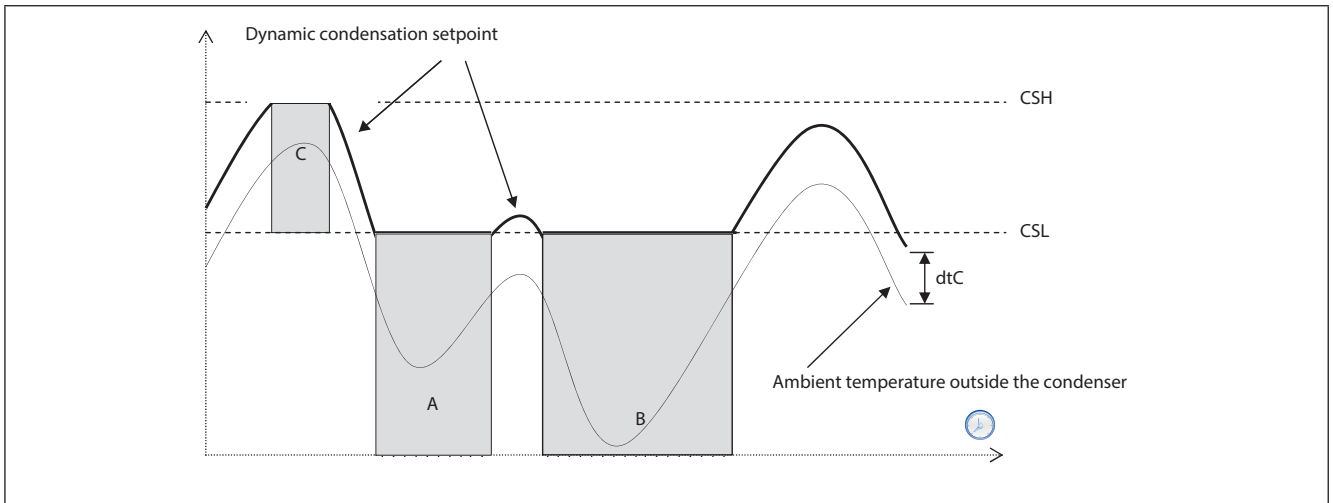

Fig. 39. Discharge floating condensation

9.2.2. Sub-cooling

Sub-cooling is used to prevent liquid returns to the condenser and prevent the refrigerant sub-cooling.

It is enabled by the sub-cooling probe, parameter **ELr=On**.

Sub-cooling **UCtemp** (see Fig. 40) is calculated by using the sub-temperature probe value, positioned upstream of the liquid receiver, and that of the discharge probe:

UCtemp = value converted to temperature (Discharge pressure) – sub-cooling probe value.

In accordance with the second diagram, a further correction is applied to the fluctuating setpoint (added to the actual setpoint).

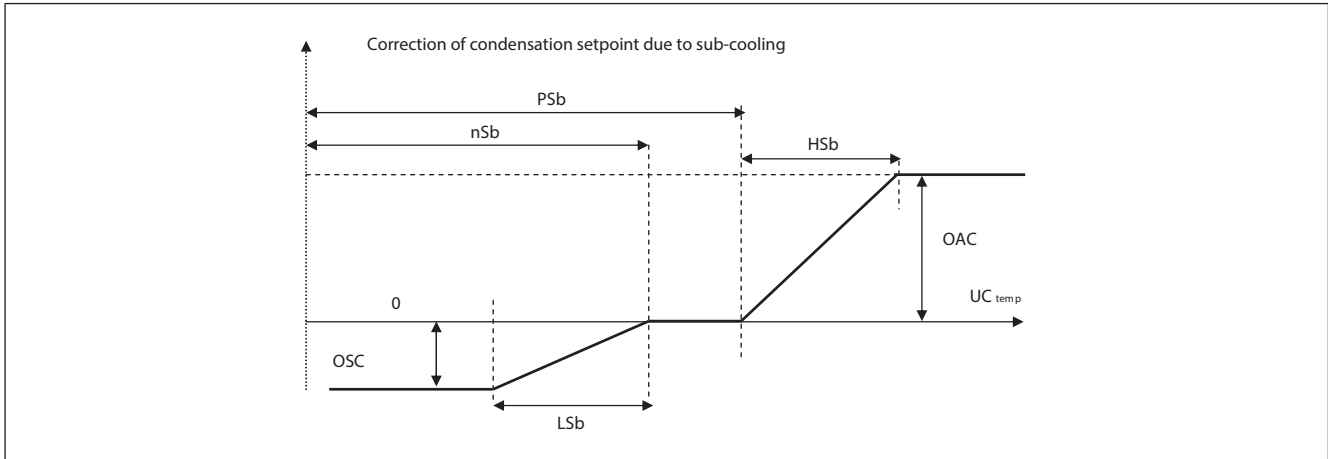

Fig. 40. Floating condensation - Sub-cooling

Note:

- **nSb** minimum sub-cooling value;
- **PSb** maximum sub-cooling value;
- If $nSb < UCtemp < PSb$ no correction;
- For external values.
 - Proportional correction with deviations $< LSb$ or HSb .
 - Fixed correction, deviations greater to or equal to **OSC** or **OAC**.

Having applied the sub-cooling, there will be the following limitations: The effective value of the floating setpoint will be limited below by **CSL** (areas A and B of the graph on the previous page (See Fig. 39).

The effective value of the floating setpoint is limited above so that it cannot take on values higher than **CSH** (Area C of the graph on the previous page)

CHAPTER 10

General Regulator

The **EWCM 400D PRO A-STD** controller can manage one relay output and one analog output configured as a general regulator. It is managed by the regulation probe configured via parameter **ACFr**:

- **ACFr = 0**, General regulator disabled;
- **ACFr = 1**, General regulator probe (probe dedicated to the general regulator);
- **ACFr = 2**, Suction Pressure Converted to a Temperature value;
- **ACFr = 3**, Fan Pressure Converted to a Temperature value;
- **ACFr = 4**, Suction Temperature;
- **ACFr = 5**, Discharge Temperature;
- **ACFr = 6**, External Temperature;
- **ACFr = 7**, Liquid Return Temperature;
- **ACFr = 8**, Overheat;
- **ACFr = 9**, Sub-cooling.

The general regulator can be configured in Hot or Cold mode by setting parameter **MCFr**:

- **MCFr = OFF**, Cold mode;
- **MCFr = On**, Hot mode.

10.1. DIGITAL OUTPUT GENERAL REGULATOR

Cold mode - **MCFr = OFF**:

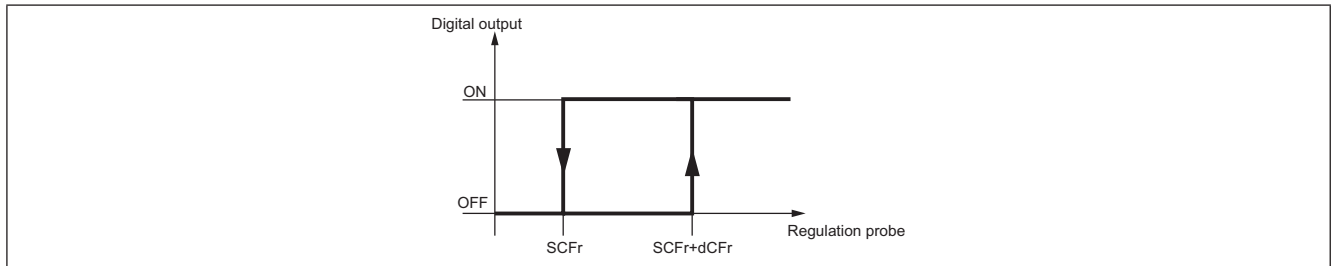

Fig. 41. Digital output general regulator - Cold mode

Hot mode - **MCFr = On**:

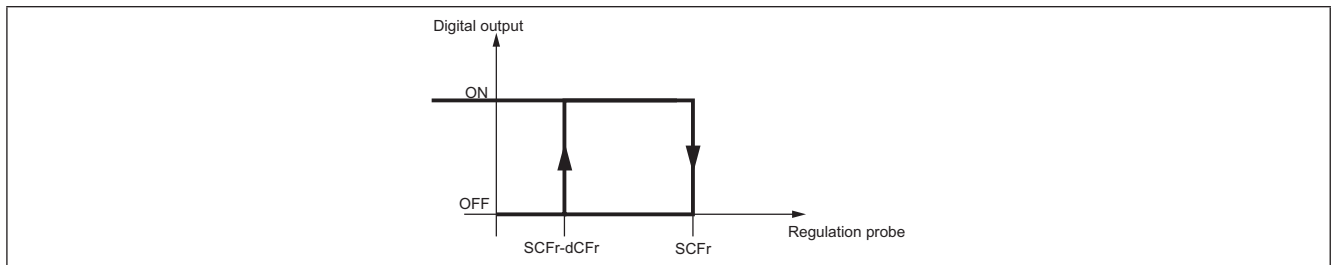

Fig. 42. Digital output general regulator - Hot mode

10.2. ANALOG OUTPUT GENERAL REGULATOR

Cold mode - **MCFr = OFF**:

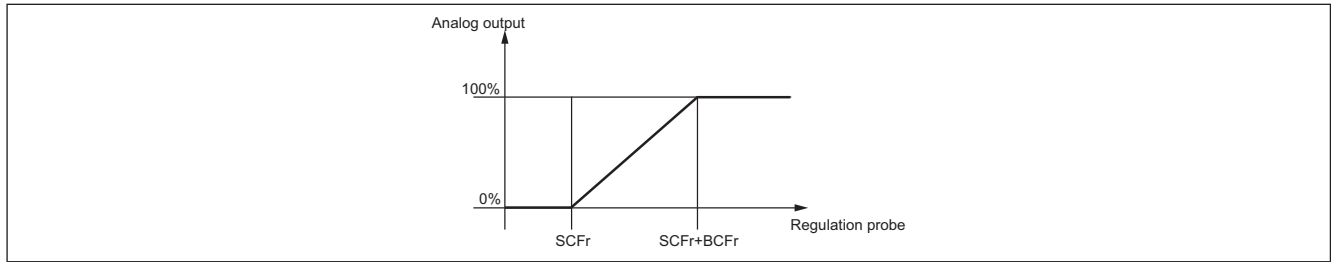

Fig. 43. Analog output general regulator - Cold mode

Hot mode - **MCFr = On**:

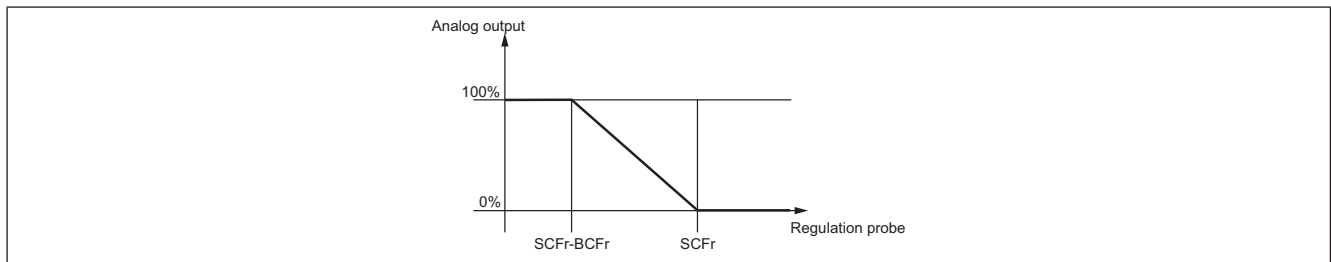

Fig. 44. Analog output general regulator - Hot mode

CHAPTER 11

Parameters (PAR)

Parameter setting allows full configuration of the **EWCM 400D PRO A-STD** controllers.

Changes can be made via:

- **MFK** and **UNICARD**.
- Keys on the front cover or the **SKP10** display.
- Personal computer and **Device Manager** software.

⚠ WARNING
UNINTENDED EQUIPMENT OPERATION
After editing the BIOS parameters the device must be switched off and on again.
Failure to follow these instructions can result in death, serious injury, or equipment damage.

11.1. PARAMETERS / VISIBILITY TABLE, FOLDER VISIBILITY TABLE AND CLIENT TABLE

The three **tables below** list all information required to read, write and decode all accessible resources in the device.

Parameters table	Contains all the configuration parameters for the device saved in the instrument's non-volatile memory, including visibility	See 11.1.1. BIOS / visibility parameters table page 71 and 11.1.3. Application parameters table page 76
Folders table	Gives the list of visibility for all parameter folders	See 11.1.4. Client Table page 89 .
Client Table	Includes all I/O and alarm status resources available in the volatile memory of the instrument	See 11.1.4. Client Table page 89

Description of the columns:

FOLDER	Indicates the label of the folder containing the parameter in question.
LABEL	Indicates the label used to display the parameters in the menu of the controller.
ADDRESS	Indicates the address of the Modbus register containing the resource to be accessed.
DATA SIZE	Indicates the size of the piece of data (in bit). The size is always in WORD = 16 bit.
CPL	When the field indicates "Y", the value read by the register needs to be converted because the value represents a number with a sign. In the other cases the value is always positive or null. To carry out conversion, proceed as follows: <ul style="list-style-type: none"> • If the value in the register is between 0 and 32,767, the result is the value itself (zero and positive values). • If the value in the register is between 32,768 and 65,535, the result is the value of the register – 65,536 (negative values).
EXP	If = -1, the value read by the register is divided by 10 (value/10) to convert it to the values indicated in the RANGE and DEFAULT columns using the unit of measure in the U.M. column Example: parameter CL10 = 50.0. Column EXP = -1: <ul style="list-style-type: none"> • The value read by the device /Device Manager software is 50.0 • The value read by the register is 500 --> 500/10 = 50.0

VISIBILITY ADDRESS	The same as above. In this case, the Modbus register address contains the visibility value of the parameter. By default all parameters have <ul style="list-style-type: none"> • data size WORD • Range 0...3 (see Setting a password (Par/PASS folder) page 46) • U.M. num
VISIBILITY VALUE	Indicates the visibility value of the parameter / folder <ul style="list-style-type: none"> • 0 = Never visible. Not visible from the instrument • 1 = Level 1 – see Ui27 • 2 = Level 2 – see Ui28 • 3 = Always visible.
R/W	Indicates the possibility for read and write, read only or write only of the resource: <ul style="list-style-type: none"> • R: the resource is read-only • W: the resource is write-only • RW: the resource can be both read and written
RANGE	Describes the interval of values that can be assigned to the parameter. It can be correlated with other parameters in the instrument (indicated with the parameter label). NOTE: if the real value is outside the permitted limits for the parameter (for example, because other parameters defining the limits have been changed), the <u>limit that has been exceeded</u> and not the real value will be displayed.
DEFAULT	Indicates the factory-set value for the standard version of the instrument.
U.M.	Unit of measure for values converted according to the rules indicated in the CPL and EXP columns. The unit of measure shown must be considered an example only, as it may change depending on the application (e.g. parameters with a U.M. in °C/bar could also have U.M. %RH)

Parameter visibility and value (BIOS parameters only)

According to the reference code, some configuration parameters may not be visible and/or many have no meaning as the associated resource is not present.

It is possible to configure four levels of visibility, assigning appropriate values to parameters and folders:

Value	Visibility level	Password entry requirement
3	Parameter or folders always visible	These (password protected) are only visible if you enter the correct password (installer or manufacturer password) using the procedure below (following table).
2	Manufacturer level These parameters and folders are only visible when the manufacturer password (see parameter Ui28) is entered (you will be able to see all parameters declared as always visible, visible at installer level and visible at manufacturer level)	
1	Installer level These parameters and folders are only visible when the installer password (see parameter Ui27) is entered (you will be able to see all parameters declared as always visible and visible at installer level)	
0	Parameter or folders NOT visible	

Unless otherwise indicated, the parameter is visible and can be modified, unless custom settings have been configured via serial port.

It is possible to check the visibility of parameters and folders. Consult the folders table.

When modifying the visibility of the folder, the new setting applies to all parameters in the folder.

The application parameters are always visible.

11.1.1. BIOS / visibility parameters table

FOLDER	LABEL	VIS PAR ADDRESS	DATA SIZE	CPL	EXP	VIS PAR ADDRESS	VIS PAR. VALUE	R/W	DESCRIPTION	RANGE	DEFAULT	UM
CE	CE00	53791	WORD			53614	3	RW	Analog input AIE1 type <ul style="list-style-type: none"> 0= Probe not configured; 1= Not used; 2= NTC; 	0 .. 2	2	num
CE	CE01	53792	WORD			53615	3	RW	Analog input AIE2 type See AIE1	0 .. 2	2	num
CE	CE02	53793	WORD			53616	3	RW	Analog input AIE3 type <ul style="list-style-type: none"> 0= Probe not configured; 1= Not used; 2= NTC; 3= 4...20 mA; 4= 0...10 V; 5= 0...5 V; 6= 0-1 V; 	0 .. 6	2	num
CE	CE03	53794	WORD			53617	3	RW	Analog input AIE4 type See AIE2	0 .. 6	2	num
CE	CE04	53795	WORD			53618	3	RW	Analog input AIE5 type See AIE2	0 .. 2	2	num
CE	CE10	15892	WORD			53619	3	RW	Analog input AIE3 fullscale value	CE11.. 99.9	50.0	°C/bar
CE	CE11	15898	WORD			53620	3	RW	Analog input AIE3 start of scale value	-50 ... CE10	0	°C/bar
CE	CE12	15893	WORD			53621	3	RW	Analog input AIE4 fullscale value	CE13.. 99.9	50.0	°C/bar
CE	CE13	15899	WORD			53622	3	RW	Analog input AIE4 start of scale value	-50 ... CE12	0	°C/bar
CE	CE20	53821	WORD			53623	3	RW	Analog input AIE1 differential	-12.0 .. 12.0	0.0	°C
CE	CE21	53822	WORD			53624	3	RW	Analog input AIE2 differential	-12.0 .. 12.0	0.0	°C
CE	CE22	53823	WORD			53625	3	RW	Analog input AIE3 differential	-12 .. 12	0	°C/bar
CE	CE23	53824	WORD			53626	3	RW	Analog input AIE4 differential	-12 .. 12	0	°C/bar
CE	CE24	53825	WORD			53627	3	RW	Analog input AIE5 differential	-12.0 .. 12.0	0.0	°C
Note: For the analog input, which is selected as the suction pressure sensor, the input values of the start and end of scale as well as the offset (calibration) must be multiplied by 10 (high resolution)												
CL	CL00	53303	WORD			53584	3	RW	Analog input AiL1 type <ul style="list-style-type: none"> 0= Probe not configured; 1= Not used; 2= NTC; 3...8= NOT USED. 	0 ... 8	2	num
CL	CL01	53304	WORD			53585	3	RW	AiL2 analog input type See CL00	0 ... 8	2	num

FOLDER	LABEL	VIS PAR ADDRESS	DATA SIZE	CPL	EXP	VIS PAR ADDRESS	VIS PAR. VALUE	R/W	DESCRIPTION	RANGE	DEFAULT	UM
CL	CL02	53305	WORD			53586	3	RW	Analog input AiL3 type <ul style="list-style-type: none"> • 0= Probe not configured; • 1= Not used; • 2= NTC; • 3= 4...20 mA; • 4= 0-10 V; • 5= 0-5 V; • 6= 0-1 V; • 7= 0..20 mA. 	0 ... 7	3	num
CL	CL03	53306	WORD			53587	3	RW	AiL4 analog input type See CL02	0 ... 7	3	num
CL	CL04	53307	WORD			53588	3	RW	AiL5 analog input type See CL00	0 ... 8	2	num
CL	CL10	15648	WORD	Y	-1	53589	3	RW	Analog input AiL3 fullscale value	CL11 ... 9999	70	°C/Bar
CL	CL11	15654	WORD	Y	-1	53590	3	RW	Analog input AiL3 start of scale value	-500 ... CL10	-5	°C/Bar
CL	CL12	15649	WORD	Y	-1	53591	3	RW	Analog input AiL4 fullscale value	CL13 ... 9999	30	°C/Bar
CL	CL13	15655	WORD	Y	-1	53592	3	RW	Analog input AiL4 start of scale value	-500 ... CL12	0	°C/Bar
CL	CL20	53333	WORD	Y	-1	53593	3	RW	Analog input AiL1 differential	-120 ... 120	0.0	°C
CL	CL21	53334	WORD	Y	-1	53594	3	RW	Analog input AiL2 differential	-120 ... 120	0.0	°C
CL	CL22	53335	WORD	Y	-1	53595	3	RW	Analog input AiL3 differential	-120 ... 120	0	°C/Bar
CL	CL23	53336	WORD	Y	-1	53596	3	RW	Analog input AiL4 differential	-120 ... 120	0	°C/Bar
CL	CL24	53337	WORD	Y	-1	53597	3	RW	Analog input AiL5 differential	-120 ... 120	0.0	°C
Note: For the analog input, which is selected as the suction pressure sensor, the input values of the start and end of scale as well as the offset (calibration) must be multiplied by 10 (high resolution)												
CF	CF01	53264	WORD			53638	3	RW	Select COM1 protocol Selection of COM1 (TTL/RS-485) communication channel protocol: 0 = Eliwell ; 1 = Modbus Note: <ul style="list-style-type: none"> • If CF01=0, parameters CF20/CF21 should be configured. • If CF01=1, parameters CF30/CF31/CF32 should be configured. COM1 = TTL/RS485 (cannot be used at the same time)	0 ... 1	1	num

FOLDER	LABEL	VIS PAR ADDRESS	DATA SIZE	CPL	EXP	VIS PAR ADDRESS	VIS PAR. VALUE	RW	DESCRIPTION	RANGE	DEFAULT	UM
CF	CF20	53271	WORD			53639	3	RW	Eliwell protocol controller address CF20 = address of the controller within the family (values valid from 0 to 14) CF21 = device family (values valid from 0 to 14) The two values CF20 and CF21 represent the network address of the device and are indicated in the format "FF.DD" (where FF= CF21 and DD= CF20).	0 ... 14	0	num
CF	CF21	53272	WORD			53640	3	RW	Eliwell protocol controller family See CF21	0 ... 14	0	num
CF	CF30	53273	WORD			53641	3	RW	Modbus protocol controller address Note: 0 (zero) is not anticipated.	1 ... 255	1	num
CF	CF31	53274	WORD			53642	3	RW	Modbus baudRate protocol <ul style="list-style-type: none"> • 0= not used; • 1= not used; • 2= not used; • 3= 9600 baud; • 4= 19200 baud; • 5= 38400 baud (RS485: not supported); • 6= 57600 baud (RS485: not supported); • 7= 115200 baud (RS485: not supported). 	0 ... 7	3	num
CF	CF32	53275	WORD			53643	3	RW	Modbus parity protocol <ul style="list-style-type: none"> • 1= Even; • 2= None; • 3= Odd. 	1 ... 3	1	num
CF	CF60	15638	WORD			53645	3	RW	Customer code 1 Parameter for the exclusive use of customers/users. The client can assign these parameters values that, for example, identify the type and/or version of the system, its configuration, etc.	0 ... 999	0	num
CF	CF61	15639	WORD			53646	3	RW	Customer code 2 See CF60	0 ... 999	0	num
UI	UI26	15714	WORD			53647	3	RW	Key hold time to enable function	0 ... 999	350	4*ms

FOLDER	LABEL	VIS PAR ADDRESS	DATA SIZE	CPL	EXP	VIS PAR ADDRESS	VIS PAR. VALUE	R/W	DESCRIPTION	RANGE	DEFAULT	UM
UI	UI27	15743	WORD			53648	1	RW	Installer password When enabled (value other than 0), it represents the access password for parameters.	0 ... 255	1	num
UI	UI28	15744	WORD			53649	2	RW	Manufacturer password When enabled (value other than 0), it represents the access password for parameters.	0 ... 255	2	num

11.1.2. Folder visibility table

LABEL	ADDRESS	R/W	DESCRIPTION	DATA SIZE	RANGE	VIS. PAR. VALUE	U.M.
_VisCarStati_Ai	53519	RW	Ai folder visibility	WORD	0 ... 3	3	num
_VisCarStati_di	53520	RW	di folder visibility	WORD	0 ... 3	3	num
_VisCarStati_AO	53521	RW	AO folder visibility	WORD	0 ... 3	3	num
_VisCarStati_dO	53522	RW	dO folder visibility	WORD	0 ... 3	3	num
VisCarStati_CL	53523	RW	CL folder visibility	WORD	0 ... 3	3	num
_VisCarProgPar	53524	RW	PAr folder visibility	WORD	0 ... 3	3	num
_VisCarFnC	53525	RW	FnC folder visibility	WORD	0 ... 3	3	num
_VisCarProgPASS	53526	RW	PASS folder visibility	WORD	0 ... 3	3	num
_VisCarPrCL	53577	RW	Par\CL folder visibility	WORD	0 ... 3	3	num
_VisCarPrCR	53578	RW	Par\Cr folder visibility	WORD	0 ... 3	3	num
_VisCarPrCE	53579	RW	Par\CE folder visibility	WORD	0 ... 3	3	num
_VisCarPrCF	53580	RW	Par\CF folder visibility	WORD	0 ... 3	3	num
_VisCarPrUi	53581	RW	Par\Ui folder visibility	WORD	0 ... 3	3	num
_VisCarTA	53582	RW	FnC\TA folder visibility	WORD	0 ... 3	3	num
_VisCarCC	53583	RW	Fnc\CC folder visibility	WORD	0 ... 3	3	num
_VisCarCC\UL	53650	RW	Fnc\CC\UL folder visibility	WORD	0 ... 3	3	num
_VisCarCC\dL	53651	RW	Fnc\CC\dL folder visibility	WORD	0 ... 3	3	num
_VisCarCC\Fr	53652	RW	Fnc\CC\Fr folder visibility	WORD	0 ... 3	3	num

11.1.3. Application parameters table

FOLDER	LABEL	ADDRESS	DATA TYPE	CMP	EXP	PARAMETER VISIBILITY	R/W	DESCRIPTION	RANGE	DEFAULT 436	DEFAULT 455	U.M.
CnF	Ert	16455	WORD			3	RW	Select type of refrigerant <ul style="list-style-type: none"> • 0 = R404A; • 1 = R22; • 2 = R744; • 3 = Reserved; • 4 = R134a; • 5 = R407C; • 6 = R410A; • 7 = R427A; • 8 = R507A; • 9 = R407A; • 10 = R717; • 11 = R407F; • 12 = R450; • 13 = R448A (liquid); • 14 = R448A (gas); • 15 = R513A; • 16 = R449A (liquid); • 17 = R449 (gas). 	0 ... 17	0	13	num
CnF	Ct1	16456	WORD			3	RW	Compressor 1 type <ul style="list-style-type: none"> • 0 = Disabled; • 1 = Semi-hermetic; • 2 = Standard; • 3 = Screw; • 4 = Inverter; • 5 = Digital Scroll. 	0 ... 5	5	4	num
CnF	nS1	16457	WORD			3	RW	Compressor 1 number of steps <p>1 = 1 step; 2 = 2 steps; 3 = 3 steps; 4 = 4 steps.</p>	1...4	1	1	num
CnF	Ct2	16458	WORD			3	RW	Compressor 2 type <ul style="list-style-type: none"> • 0 = Disabled; • 1 = Semi-hermetic; • 2 = Standard; 	0 ... 2	0	2	num

FOLDER	LABEL	ADDRESS	DATA TYPE	CMP	EXP	PARAMETER VISIBILITY	R/W	DESCRIPTION	RANGE	DEFAULT 436	DEFAULT 455	U.M.
CnF	nS2	16459	WORD			3	RW	Number of steps- compressor 2 <ul style="list-style-type: none"> 1= 1 step; 2= 2 steps; 3= 3 steps; 4= 4 steps. 	1...4	1	1	num
CnF	Ct3	16460	WORD			3	RW	Compressor 3 type <ul style="list-style-type: none"> 0 = Disabled; 1 = Semi-hermetic; 2 = Standard; 	0 ... 2	0	2	num
CnF	nS3	16461	WORD			3	RW	Number of steps- compressor 3 <ul style="list-style-type: none"> 1= 1 step; 2= 2 steps; 3= 3 steps; 4= 4 steps. 	1...4	1	1	num
CnF	Ct4	16462	WORD			3	RW	Compressor 4 type <ul style="list-style-type: none"> 0 = Disabled; 1 = Semi-hermetic; 2 = Standard; 	0 ... 2	0	0	num
CnF	nS4	16463	WORD			3	RW	Number of steps- compressor 4 <ul style="list-style-type: none"> 1= 1 step; 2= 2 steps; 3= 3 steps; 4= 4 steps. 	1...4	1	1	num
CnF	CPE	16464	WORD			3	RW	Number of active steps in the event of a probe fault	0...16	1	2	num
CnF	nFn	16465	WORD			3	RW	Number of digital fans <ul style="list-style-type: none"> 0 = No digital output configured for fan control; 1 = 1 digital output configured for fan control; 2 = 2 digital outputs configured for fan control. 3 = 3 digital outputs configured for fan control; 4 = 4 digital outputs configured for fan control. 	0 ... 4	0	0	num
CnF	nFA	16466	WORD			3	RW	Number of analog fans <ul style="list-style-type: none"> 0= No analog output; 1= 1 fan. 	0/1	1	1	num

FOLDER	LABEL	ADDRESS	DATA TYPE	CMP	EXP	PARAMETER VISIBILITY	R/W	DESCRIPTION	RANGE	DEFAULT 436	DEFAULT 455	U.M.
CnF	FtE	16467	WORD			3	RW	Enable discharge probe <ul style="list-style-type: none"> 0= disabled; 1= enabled. 	0/1	0	0	Flag
CnF	CtE	16468	WORD			3	RW	Enable suction probe <ul style="list-style-type: none"> 0= disabled; 1= enabled. 	0/1	0	0	Flag
CnF	Eet	16469	WORD			3	RW	Enable external temperature probe <ul style="list-style-type: none"> 0= disabled; 1= enabled. 	0/1	0	0	Flag
CnF	Elr	16470	WORD			3	RW	Enable sub-cooling probe <ul style="list-style-type: none"> 0= disabled; 1= enabled. 	0/1	0	0	Flag
CnF	EnEP	16471	WORD			3	RW	Enable expansion device <ul style="list-style-type: none"> 0= disabled; 1= enabled. 	0/1	0	0	Flag
CnF	CPi	16476	WORD			3	RW	Percentage of power supplied by the inverter/DGS compressor in the event of a probe error	0 ... 100	0	0	%
AI	01P	16433	WORD			3	RW	Configurability of analog input 1 <ul style="list-style-type: none"> 0 = Disabled; 1 = Suction Temperature/ Pressure (Compressor regulation probe); 2 = Discharge Temperature/ Pressure (Fan regulation probe); 3 = External temperature; 4 = Liquid return temperature; 5 = Discharge temperature; 6 = Suction temperature (calculate superheat); 7 = General regulator temperature 	0 ... 7	0	0	num
AI	02P	16434	WORD			3	RW	Configurability of analog input 2. As per 01P.	0 ... 7	0	0	num
AI	03P	16435	WORD			3	RW	Configurability of analog input 3. As per 01P.	0 ... 7	1	1	num
AI	04P	16436	WORD			3	RW	Configurability of analog input 4. As per 01P.	0 ... 7	2	2	num
AI	05P	16437	WORD			3	RW	Configurability of analog input 5. As per 01P.	0 ... 7	0	0	num
AI	11P	16438	WORD			3	RW	Configurability of expansion device analog input 1. As per 01P.	0 ... 7	0	0	num

FOLDER	LABEL	ADDRESS	DATA TYPE	CMP	EXP	PARAMETER VISIBILITY	R/W	DESCRIPTION	RANGE	DEFAULT 436	DEFAULT 455	U.M.
AI	12P	16439	WORD			3	RW	Configurability of expansion device analog input 2. As per 01P.	0 ... 7	0	0	num
AI	13P	16440	WORD			3	RW	Configurability of expansion device analog input 3. As per 01P.	0 ... 7	0	0	num
AI	14P	16441	WORD			3	RW	Configurability of expansion device analog input 4. As per 01P.	0 ... 7	0	0	num
AI	15P	16442	WORD			3	RW	Configurability of expansion device analog input 5. As per 01P.	0 ... 7	0	0	num
di	d01	16421	WORD	Y		3	RW	<p>Configurability of digital input 1.</p> <ul style="list-style-type: none"> • 0 = Disabled; • ±1 = Compressor 1 thermal switch; • ±2 = Compressor 2 thermal switch; • ±3 = Compressor 3 thermal switch; • ±4 = Compressor 4 thermal switch; • ±5 = Fan 1 thermal switch; • ±6 = Fan 2 thermal switch; • ±7 = Fan 3 thermal switch; • ±8 = Fan 4 thermal switch; • ±9 = Remote on-off; • ±10 = High pressure switch; • ±11 = Low pressure switch; • ±12 = Fan Inverter Thermal switch; • ±13 = Enable reduced suction set; • ±14 = Enable reduced discharge set; • ±15 = External alarm; • ±16 = Enable floating condensation; • ±17 = Refrigerant level; • ±18 = Night mode; <p>- The "+" sign indicates that the input is active when the contact is closed. - The "-" sign indicates that the input is active when the contact is open.</p>	-18 ... 18	-1	-1	num
di	d02	16422	WORD	Y		3	RW	Configurability of digital input 2. As per i01.	-18 ... 18	-12	-2	num

FOLDER	LABEL	ADDRESS	DATA TYPE	CMP	EXP	PARAMETER VISIBILITY	R/W	DESCRIPTION	RANGE	DEFAULT 436	DEFAULT 455	U.M.
di	d03	16423	WORD	Y		3	RW	Configurability of digital input 3. As per i01.	-18 ... 18	0	-3	num
di	d04	16424	WORD	Y		3	RW	Configurability of digital input 4. As per i01.	-18 ... 18	0	-12	num
di	d05	16425	WORD	Y		3	RW	Configurability of digital input 5. As per i01.	-18 ... 18	0	9	num
di	d06	16426	WORD	Y		3	RW	Configurability of digital input 6. As per i01.	-18 ... 18	0	0	num
di	d11	16427	WORD	Y		3	RW	Configurability of digital input 7. As per i01.	-18 ... 18	0	0	num
di	d12	16428	WORD	Y		3	RW	Configurability of digital input 8. As per i01.	-18 ... 18	0	0	num
di	d13	16429	WORD	Y		3	RW	Configurability of digital input 9. As per i01.	-18 ... 18	0	0	num
di	d14	16430	WORD	Y		3	RW	Configurability of digital input 10. As per i01.	-18 ... 18	0	0	num
di	d15	16431	WORD	Y		3	RW	Configurability of digital input 11. As per i01.	-18 ... 18	0	0	num
di	d16	16432	WORD	Y		3	RW	Configurability of digital input 12. As per i01.	-18 ... 18	0	0	num

FOLDER	LABEL	ADDRESS	DATA TYPE	CMP	EXP	PARAMETER VISIBILITY	R/W	DESCRIPTION	RANGE	DEFAULT 436	DEFAULT 455	U.M.
AO	01n	16411	WORD	Y		3	RW	Configurability of analog output 1. <ul style="list-style-type: none"> • 0 = Disabled; • ±1 = Digital Fan 1; • ±2 = Digital Fan 2; • ±3 = Digital Fan 3; • ±4 = Digital Fan 4; • ±5 = Compressor 1 drive; • ±6 = CP1 Step 1 drive; • ±7 = CP1 Step 2 drive; • ±8 = CP1 Step 3 drive; • ±9 = Compressor 2 drive; • ±10 = CP2 Step 1 drive; • ±11 = CP2 Step 2 drive; • ±12 = CP2 Step 3 drive; • ±13 = Compressor 3 drive; • ±14 = CP3 Step 1 drive; • ±15 = CP3 Step 2 drive; • ±16 = CP3 Step 3 drive; • ±17 = Compressor 4 drive; • ±18 = CP4 Step 1 drive; • ±19 = CP4 Step 2 drive; • ±20 = CP4 Step 3 drive; • ±21 = DGS coil drive; • ±22 = Inverter Fan drive; • ±23 = Alarm; • ±24 = Night Mode active; • ±25 = General regulator; <p>- The "+" sign indicates that the output is active when the contact is closed. - The "-" sign indicates that the output is active when the contact is open.</p>	-25 .. 25	0	0	num
AO	02n	16412	WORD	Y		3	RW	Configurability of analog output 2. As per 01n.	-25 .. 25	0	0	num

FOLDER	LABEL	ADDRESS	DATA TYPE	CMP	EXP	PARAMETER VISIBILITY	R/W	DESCRIPTION	RANGE	DEFAULT 436	DEFAULT 455	U.M.
AO	03n	16413	WORD	Y		3	RW	Configurability of analog output 3. As per 01n. 03n, 04n, 05n, 13n, 14n, 15n only: <ul style="list-style-type: none"> • 26 = Compressor Inverter; • 27 = Fan Inverter; • 28 = General regulator Analog Output; 	-25 .. 28	27	26	num
AO	04n	16414	WORD	Y		3	RW	Configurability of analog output 4. As per 01n/03n.	-25 .. 28	0	27	num
AO	05n	16415	WORD	Y		3	RW	Configurability of analog output 5. As per 01n/03n.	-25 .. 28	0	0	num
AO	11n	16416	WORD	Y		3	RW	Configurability of expansion device analog output 1. As per 01n.	-25 .. 25	0	0	num
AO	12n	16417	WORD	Y		3	RW	Configurability of expansion device analog output 2. As per 01n.	-25 .. 25	0	0	num
AO	13n	16418	WORD	Y		3	RW	Configurability of expansion device analog output 3. As per 01n/03n.	-25 .. 28	0	0	num
AO	14n	16419	WORD	Y		3	RW	Configurability of expansion device analog output 4. As per 01n/03n.	-25 .. 28	0	0	num
AO	15n	16420	WORD	Y		3	RW	Configurability of expansion device analog output 5. As per 01n/03n.	-25 .. 28	0	0	num

FOLDER	LABEL	ADDRESS	DATA TYPE	CMP	EXP	PARAMETER VISIBILITY	R/W	DESCRIPTION	RANGE	DEFAULT 436	DEFAULT 455	U.M.
dO	d01	16399	WORD	Y		3	RW	Configurability of digital output 1. <ul style="list-style-type: none"> • 0 = Disabled; • ±1 = Digital Fan 1; • ±2 = Digital Fan 2; • ±3 = Digital Fan 3; • ±4 = Digital Fan 4; • ±5 = Compressor 1 drive; • ±6 = CP1 Step 1 drive; • ±7 = CP1 Step 2 drive; • ±8 = CP1 Step 3 drive; • ±9 = Compressor 2 drive; • ±10 = CP2 Step 1 drive; • ±11 = CP2 Step 2 drive; • ±12 = CP2 Step 3 drive; • ±13 = Compressor 3 drive; • ±14 = CP3 Step 1 drive; • ±15 = CP3 Step 2 drive; • ±16 = CP3 Step 3 drive; • ±17 = Compressor 4 drive; • ±18 = CP4 Step 1 drive; • ±19 = CP4 Step 2 drive; • ±20 = CP4 Step 3 drive; • ±21 = DGS coil drive; • ±22 = Inverter Fan drive; • ±23 = Alarm; • ±24 = Night Mode; • ±25 = General regulator. <p>- The "+" sign indicates that the output is active when the contact is closed. - The "-" sign indicates that the output is active when the contact is open.</p>	-25 .. 25	5	5	num
dO	d02	16400	WORD	Y		3	RW	Configurability of digital output 2. As per d01.	-25 .. 25	22	9	num
dO	d03	16401	WORD	Y		3	RW	Configurability of digital output 3. As per d01.	-25 ... 28	0	13	num
dO	d04	16402	WORD	Y		3	RW	Configurability of digital output 4. As per d01.	-25 ... 28	0	22	num
dO	d05	16403	WORD	Y		3	RW	Configurability of digital output 5. As per d01.	-25 ... 28	0	23	num

FOLDER	LABEL	ADDRESS	DATA TYPE	CMP	EXP	PARAMETER VISIBILITY	R/W	DESCRIPTION	RANGE	DEFAULT 436	DEFAULT 455	U.M.
dO	d06	16404	WORD	Y		3	RW	Configurability of digital output 6. As per d01.	-25 ... 25	21	0	num
dO	d11	16405	WORD	Y		3	RW	Configurability of expansion device digital output 1. As per d01.	-25 ... 25	0	0	num
dO	d12	16406	WORD	Y		3	RW	Configurability of expansion device digital output 2. As per d01.	-25 ... 28	0	0	num
dO	d13	16407	WORD	Y		3	RW	Configurability of expansion device digital output 3. As per d01.	-25 ... 28	0	0	num
dO	d14	16408	WORD	Y		3	RW	Configurability of expansion device digital output 4. As per d01.	-25 ... 28	0	0	num
dO	d15	16409	WORD	Y		3	RW	Configurability of expansion device digital output 5. As per d01.	-25 .. 25	0	0	num
dO	d16	16410	WORD	Y		3	RW	Configurability of expansion device digital output 6. As per d01.	-25 .. 25	0	0	num
LEd	01u	16443	WORD			3	RW	Configuration of LED 1 <ul style="list-style-type: none"> • 0 = Disabled; • 1 = Digital Fan 1; • 2 = Digital Fan 2; • 3 = Digital Fan 3; • 4 = Digital Fan 4; • 5 = Compressor 1 drive; • 6 = Compressor 2 drive; • 7 = Compressor 3 drive; • 8 = Compressor 4 drive; • 9 = DGS coil drive; • 10 = Inverter Fan drive; • 11 = CP1 Step 1 drive; • 12 = CP1 Step 2 drive; • 13 = CP1 Step 3 drive; • 14 = CP2 Step 1 drive; • 15 = CP2 Step 2 drive; • 16 = CP2 Step 3 drive; • 17 = CP3 Step 1 drive; • 18 = CP3 Step 2 drive; • 19 = CP3 Step 3 drive; • 20 = CP4 Step 1 drive; • 21 = CP4 Step 2 drive; • 22 = CP4 Step 3 drive; • 23 = General regulator 	0 ... 23	5	5	num
LEd	02u	16444	WORD			3	RW	Configuration of LED 2. As per 01u.	0 ... 23	9	6	num

FOLDER	LABEL	ADDRESS	DATA TYPE	CMP	EXP	PARAMETER VISIBILITY	R/W	DESCRIPTION	RANGE	DEFAULT 436	DEFAULT 455	U.M.
LEd	03u	16445	WORD			3	RW	Configuration of LED 3. As per 01u.	0 ... 23	10	7	num
LEd	04u	16446	WORD			3	RW	Configuration of LED 4. As per 01u.	0 ... 23	0	10	num
LEd	05u	16447	WORD			3	RW	Configuration of LED 5. As per 01u.	0 ... 23	0	0	num
LEd	06u	16448	WORD			3	RW	Configuration of LED 6. As per 01u.	0 ... 23	0	0	num
LEd	07u	16449	WORD			3	RW	Configuration of LED 7. As per 01u.	0 ... 23	0	0	num
CPr	SP1	16481	WORD	Y	-2	3	RW	Pressure setpoint in the suction section	0.00 ... 10.00	1.00	1.00	bar
CPr	CCFn	16482	WORD			3	RW	Compressor control type • 0 = Neutral area; • 1 = Proportional band.	0/1	0	1	flag
CPr	bH	16483	WORD		-1	3	RW	Upper band 1 neutral zone	0.1 ... 5	0,2	0,2	bar
CPr	bHO	16484	WORD		-1	3	RW	Upper band 2 neutral zone	0.1 ... 5	0,2	0,2	bar
CPr	bL	16485	WORD		-1	3	RW	Lower band 1 neutral zone	0.1 ... 5	0,2	0,2	bar
CPr	bLO	16486	WORD		-1	3	RW	Lower band 2 neutral zone	0.1 ... 5	0,2	0,2	bar
CPr	dH	16487	WORD			3	RW	Time over upper band 1 for compressor capacity increase	0 ... 600	30	30	s
CPr	dHO	16488	WORD			3	RW	Time over upper band 2 for compressor capacity increase	0 ... 600	15	15	s
CPr	dL	16489	WORD			3	RW	Time under lower band 1 for compressor capacity decrease	0 ... 600	10	10	s
CPr	dLO	16490	WORD			3	RW	Time under lower band 2 for compressor capacity decrease	0 ... 600	5	5	s
CPr	CBn	16491	WORD		-2	3	RW	Proportional band	0.00 ... 99.99	0,3	0,3	bar
CPr	CdOn	16492	WORD			3	RW	Compressor power minimum increase interval with proportional band regulation	0 ... 9999	30	30	s
CPr	CdOF	16493	WORD			3	RW	Compressor power minimum decrease interval with proportional band regulation	0 ... 9999	15	15	s
CPr	OS1	16494	WORD	Y	-2	3	RW	Offset on setpoint	-9.99 .. 10	0	0	bar
CPP	OF1	16504	WORD			3	RW	OFF to ON compressor safety time, suction section 1	0 ... 9999	60	60	s
CPP	OF2	16505	WORD			3	RW	OFF to ON compressor safety time, suction section 2	0 ... 9999	60	60	s
CPP	OF3	16506	WORD			3	RW	OFF to ON compressor safety time, suction section 3	0 ... 9999	60	60	s
CPP	OF4	16507	WORD			3	RW	OFF to ON compressor safety time, suction section 4	0 ... 9999	60	60	s
CPP	On1	16500	WORD			3	RW	ON to ON compressor safety time, suction section 1	0 ... 9999	60	60	s
CPP	On2	16501	WORD			3	RW	ON to ON compressor safety time, suction section 2	0 ... 9999	60	60	s
CPP	On3	16502	WORD			3	RW	ON to ON compressor safety time, suction section 3	0 ... 9999	60	60	s

FOLDER	LABEL	ADDRESS	DATA TYPE	CMP	EXP	PARAMETER VISIBILITY	R/W	DESCRIPTION	RANGE	DEFAULT 436	DEFAULT 455	U.M.
CPP	On4	16503	WORD			3	RW	ON to ON compressor safety time, suction section 4	0 ... 9999	60	60	s
CPP	onF1	16508	WORD			3	RW	Compressor 1 minimum output activation time	0 ... 9999	10	10	s
CPP	onF2	16509	WORD			3	RW	Compressor 2 minimum output activation time	0 ... 9999	10	10	s
CPP	onF3	16510	WORD			3	RW	Compressor 3 minimum output activation time	0 ... 9999	10	10	s
CPP	onF4	16511	WORD			3	RW	Compressor 4 minimum output activation time	0 ... 9999	10	10	s
CPi	Cbi	16517	WORD		-2	3	RW	Compressor PID proportional band	0 .. 99.99	0,30	0,30	num
CPi	Cti	16518	WORD			3	RW	Inverter compressor integral time	0 .. 9999	0	0	num
CPi	Ctr	16519	WORD			3	RW	Inverter/DGS compressor PI regulator sampling time	10 ... 255	10	10	s/10
CPi	CAP	16520	WORD			3	RW	Inverter/DGS compressor mode with proportional band regulation • 0 = Operation change disabled; • 1 = Operation change enabled.	0 .. 1	1	1	flag
CPi	CPPm	16522	WORD			3	RW	Inverter/DGS compressor minimum output %	0 .. 100	20	20	%
CPi	PWmp	16523	WORD			3	RW	PWM period	10 ... 9999	20	20	s
CPi	Cip	16524	WORD			3	RW	Maximum increment for second inverter/DGS compressor PI regulator	0 .. 100	0.0	0.0	%
CPi	Cdp	16525	WORD			3	RW	Maximum decrease for second inverter/DGS compressor PI regulator	0 .. 100	0.0	0.0	%
CPi	InSH	16526	WORD			3	RW	Operation change on time, inverter at minimum	0 .. 9999	10	10	s
Cpi	InSL	16527	WORD			3	RW	Operation change off time, inverter at maximum	0 .. 9999	0	0	s
FAn	SP2	16533	WORD			3	RW	Pressure setpoint, discharge section	0 .. 50	16	16	bar
FAn	FBn	16534	WORD			3	RW	Proportional pressure band, discharge section	0 .. 50	2	2	bar
FAn	Fdn	16535	WORD			3	RW	Fan enabling delay from acknowledgment	0 .. 600	5	5	s
FAn	FdF	16536	WORD			3	RW	Fan deactivation delay	0 .. 600	5	5	s
FAn	OS2	16537	WORD	Y		3	RW	Offset on setpoint	-50 ... 50	0	0	bar
FAi	FPb	16544	WORD		-1	3	RW	Fan PID proportional band	0 .. 999.9	2	2	num
FAi	Fti	16545	WORD			3	RW	Fans PID controller integral time	0 .. 9999	0	0	num
FAi	Ftr	16546	WORD			3	RW	PID controller sampling time	10 ... 255	10	10	s/10
FAi	LLP	16547	WORD			3	RW	Fan PID minimum output %	0 .. 100	20	20	%

FOLDER	LABEL	ADDRESS	DATA TYPE	CMP	EXP	PARAMETER VISIBILITY	R/W	DESCRIPTION	RANGE	DEFAULT 436	DEFAULT 455	U.M.
FAi	HLP	16548	WORD			3	RW	Fan PID output max. daytime percentage	0 .. 100	100	100	%
FAi	Fip	16549	WORD			3	RW	Maximum increment for second fan compressor PI regulator	0 .. 100	0	0	%
FAi	Fdp	16550	WORD			3	RW	Maximum decrease for second fan compressor PI regulator	0 .. 100	0	0	%
FAi	Non	16551	WORD			3	RW	Fan noise reduction mode start time	Nof .. 1440	1380	1380	min
FAi	Nof	16552	WORD			3	RW	Fan noise reduction mode end time	0 .. 1440	360	360	min
FAi	NhE	16553	WORD			3	RW	Select noise reduction activation mode	0 .. 1	0	0	flag
FAi	HLn	16554	WORD			3	RW	Fan PID output max. night-time percentage	0 .. 100	90	90	%
FAi	MLP	16555	WORD		-1	3	RW	Discharge probe value, fan forcing at 100%	0 .. 999.9	20	20	bar
FAF	EdC	16561	WORD			3	RW	Selection of dynamic condensation setpoint • 0 = Function disabled; • 1 = Function enabled.	0 .. 1	0	0	flag
FAF	dtC	16562	WORD		-1	3	RW	Dynamic condensation setpoint temperature offset	0 .. 20.0	10,0	10,0	°C
FAF	oAC	16565	WORD		-1	3	RW	Floating condensation setpoint maximum offset	0 .. 50	10	10	°C
FAF	oSC	16566	WORD		-1	3	RW	Floating condensation setpoint minimum offset	0 .. 50	0	0	°C
FAF	CSH	16563	WORD		-1	3	RW	Floating condensation setpoint maximum value	5.0 .. 30.0	17,0	17,0	bar
FAF	CSL	16564	WORD		-1	3	RW	Floating condensation setpoint minimum value	5.0 .. 30.0	13,0	13,0	bar
FAF	PSb	16567	WORD	Y	-1	3	RW	Sub-cooling setpoint 1 for dynamic condensation setpoint in discharge	-50.0... 50.0	6,0	6,0	°C
FAF	nSb	16568	WORD	Y	-1	3	RW	Sub-cooling setpoint 2 for dynamic condensation setpoint in discharge	-50.0... 50.0	3,0	3,0	°C
FAF	HSb	16569	WORD		-1	3	RW	Sub-cooling maximum band	0 .. 50.0	8,0	8,0	°C
FAF	LSb	16570	WORD		-1	3	RW	Sub-cooling minimum band	0 .. 50.0	1,0	1,0	°C
FAF	HEt	16571	WORD		-1	3	RW	Maximum external temperature for floating condensation	0 .. 50.0	28,0	28,0	°C
ALr	dHA	16575	WORD			3	RW	High pressure alarm activation threshold in discharge	0 .. 30	20	20	bar
ALr	dLA	16576	WORD			3	RW	Low pressure alarm activation threshold in discharge	0 .. 30	7	7	bar
ALr	dHAd	16577	WORD		-1	3	RW	Maximum pressure alarm activation delta in discharge	0.1... 1	1	1	bar
ALr	dLAd	16578	WORD		-1	3	RW	Low pressure alarm activation delta in discharge	0.1... 1	1	1	bar
ALr	SHA	16579	WORD			3	RW	High pressure alarm activation threshold, suction section	0 .. 8	5	5	bar

FOLDER	LABEL	ADDRESS	DATA TYPE	CMP	EXP	PARAMETER VISIBILITY	R/W	DESCRIPTION	RANGE	DEFAULT 436	DEFAULT 455	U.M.
ALr	SLA	16580	WORD			3	RW	Low pressure alarm activation threshold, suction section	0 .. 8	0,2	0,2	bar
ALr	SHAd	16581	WORD		-2	3	RW	High pressure alarm activation delta, suction section	0.01 .. 1	0,5	0,5	bar
ALr	SLAd	16582	WORD		-2	3	RW	Low pressure alarm activation delta, suction section	0.01 .. 1	0,5	0,5	bar
ALr	dtA	16583	WORD		-1	3	RW	Maximum temperature alarm activation threshold in discharge	0 .. 110.0	100,0	100,0	°C
ALr	dtd	16584	WORD		-1	3	RW	Maximum temperature alarm activation delta in discharge	0.1... 50.0	10,0	10,0	°C
ALr	dt	16585	WORD			3	RW	High temperature and high/low pressure alarms bypass	0 .. 60	5	5	min
ALr	oHt	16586	WORD	Y	-1	3	RW	Maximum overheating threshold	-99.9... 100.0	30,0	30,0	°C
ALr	oLt	16587	WORD	Y	-1	3	RW	Minimum overheating threshold	-99.9... 100.0	2,0	2,0	°C
ALr	odt	16588	WORD		-1	3	RW	Overheating differential	0.1... 50.0	2,0	2,0	°C
ALr	oAd	16589	WORD			3	RW	Overheating alarm delay	0 .. 60	5	5	min
ALr	PenS	16590	WORD			3	RW	Max. number of low overheating alarms in the metering interval	0 .. 9999	5	5	num
ALr	PeiS	16591	WORD			3	RW	Low overheating alarms metering interval	1 ... 9999	15	15	min
ALr	RA	16592	WORD			3	RW	Low refrigerant alarm indication time	0 .. 9999	120	120	s
ALr	oAM	16593	WORD			3	RW	Overheating alarm management • 0 = warning; • 1 = lock.	0 .. 1	0	0	flag
ALr	dAM	16594	WORD			3	RW	High discharge temperature alarm type • 0 = warning; • 1 = lock.	0 .. 1	0	0	flag
CR	MCFr	16600	WORD			3	RW	Configurable regulator control type	0 .. 1	0	0	num
CR	ACFr	16601	WORD			3	RW	Configurable regulator probe selection	0 .. 9	0	0	num
CR	SCFr	16602	WORD	Y	-1	3	RW	Configurable regulator setpoint	-99.9... 999.9	0	0	°C
CR	dCFr	16603	WORD		-1	3	RW	Configurable regulator delta	0.1... 999.9	2,0	2,0	°C
CR	BCFr	16604	WORD		-1	3	RW	Configurable regulator band	0.1... 999.9	0,5	0,5	°C

11.1.4. Client Table



















FOLDER	LABEL	ADDRESS	R/W	DESCRIPTION	DATA TYPE	CML	RANGE	EXP	U.M.
AI	AI1	8960	R	Suction probe	WORD	Y	-3200.0 .. 3200.0	-1	°C
AI	AI2	8961	R	Suction probe	WORD	Y	-320 .. 320	-2	bar
AI	AI3	8962	R	Discharge probe	WORD	Y	-3200.0 .. 3200.0	-1	°C
AI	AI4	8963	R	Discharge probe	WORD	Y	-3200 .. 3200	-1	bar
AI	AI5	8964	R	External ambient probe	WORD	Y	-3200.0 .. 3200.0	-1	°C
AI	AI6	8966	R	Discharge temperature probe	WORD	Y	-3200.0 .. 3200.0	-1	°C
AI	AI7	8968	R	Suction temperature probe	WORD	Y	-3200.0 .. 3200.0	-1	°C
AI	AI8	8965	R	Liquid return temperature probe	WORD	Y	-3200.0 .. 3200.0	-1	°C
AI	AI9	8969	R	Valve overheating temperature	WORD	Y	-3200.0 .. 3200.0	-1	°C
AI	AI10	8967	R	Sub-cooling probe	WORD	Y	-3200.0 .. 3200.0	-2	°C
AI	AI11	8970	R	General regulator 1 probe	WORD	Y	-3200.0 .. 3200.0	-1	°C
AI	SetA	8977	R	Suction setpoint	WORD	Y	-320 .. 320		bar
AI	SetM	8978	R	Discharge setpoint	WORD	Y	-3200 .. 3200		bar
Status	StRL	9027	R	General regulator 1 digital output	WORD		0 .. 1		flag
AI	StAO	9028	R	General regulator analog output	WORD		0 .. 100		%
Status	StC1	9011	R	Compressor 1	WORD		0 .. 1		flag
Status	StC2	9012	R	Compressor 2	WORD		0 .. 1		flag
Status	StC3	9013	R	Compressor 3	WORD		0 .. 1		flag
Status	StC4	9014	R	Compressor 4	WORD		0 .. 1		flag
AI	PCi	9009	R	Power generated by inverter-driven compressor, suction section	WORD		0 .. 100		%
Status	StF1	9021	R	Fans 1	WORD		0 .. 1		flag
Status	StF2	9022	R	Fans 2	WORD		0 .. 1		flag
Status	StF3	9023	R	Fans 3	WORD		0 .. 1	-1	flag
Status	StF4	9024	R	Fans 4	WORD		0 .. 1		flag
Status	StFi	9020	R	Fan driven by inverter, discharge section	WORD		0 .. 1		flag
AI	Pfi	9019	R	Power generated by fans driven by inverter in the discharge section	WORD		0 .. 100		%
Status	Eco	9030	R	Economy, discharge section	WORD		0 .. 1		flag
Status	OnOff	9029	R	Device status	WORD		0 .. 1		flag

FOLDER	LABEL	ADDRESS	R/W	DESCRIPTION	DATA TYPE	CML	RANGE	EXP	U.M.
Status	Alrm	9026	R	Alarm	WORD		0 .. 1		flag
Alarm	Er01	9035	R	Suction pressure input failure	WORD		0 .. 1		flag
Alarm	Er02	9036	R	Discharge probe error	WORD		0 .. 1		flag
Alarm	Er03	9037	R	External temperature probe error	WORD		0 .. 1		flag
Alarm	Er04	9038	R	Liquid return temperature probe error	WORD		0 .. 1		flag
Alarm	Er05	9039	R	Discharge temperature probe error	WORD		0 .. 1		flag
Alarm	Er06	9040	R	Suction temperature input failure	WORD		0 .. 1		flag
Alarm	Er07	9041	R	High discharge temperature alarm	WORD		0 .. 1		flag
Alarm	Er08	9042	R	General regulator 1 probe fault	WORD		0 .. 1		flag
Alarm	Er10	9043	R	Compressor 1 thermal switch alarm	WORD		0 .. 1		flag
Alarm	Er11	9044	R	Compressor 2 thermal switch alarm	WORD		0 .. 1		flag
Alarm	Er12	9045	R	Compressor 3 thermal switch alarm	WORD		0 .. 1		flag
Alarm	Er13	9046	R	Compressor 4 thermal switch alarm	WORD		0 .. 1		flag
Alarm	Er20	9047	R	Fan 1 thermal switch	WORD		0 .. 1		flag
Alarm	Er21	9048	R	Fan 2 thermal switch	WORD		0 .. 1		flag
Alarm	Er22	9049	R	Fan 3 thermal switch	WORD		0 .. 1		flag
Alarm	Er23	9050	R	Fan 4 thermal switch	WORD		0 .. 1		flag
Alarm	Er24	9051	R	Thermal switch for fan driven by inverter	WORD		0 .. 1		flag
Alarm	Er30	9052	R	High pressure switch	WORD		0 .. 1		flag
Alarm	Er31	9053	R	Low pressure switch	WORD		0 .. 1		flag
Alarm	Er40	9054	R	Discharge probe maximum	WORD		0 .. 1		flag
Alarm	Er41	9055	R	Discharge probe minimum	WORD		0 .. 1		flag
Alarm	Er42	9056	R	Suction section high pressure	WORD		0 .. 1		flag
Alarm	Er43	9057	R	Suction section low pressure	WORD		0 .. 1		flag
Alarm	Er44	9058	R	Low overheating alarm	WORD		0 .. 1		flag
Alarm	Er45	9059	R	High overheating alarm	WORD		0 .. 1		flag
Alarm	Er46	9060	R	Manual low overheating alarm	WORD		0 .. 1		flag
Alarm	Er47	9061	R	Low liquid refrigerant level	WORD		0 .. 1		flag
Alarm	Er50	9062	R	Expansion device 1 no communication alarm	WORD		0 .. 1		flag
Command	rC1	9068	W	Reset compressor 1 running time	WORD		0 .. 1		flag
Command	rC2	9069	W	Reset compressor 2 running time	WORD		0 .. 1		flag
Command	rC3	9070	W	Reset compressor 3 running time	WORD		0 .. 1		flag
Command	rC4	9071	W	Reset compressor 4 running time	WORD		0 .. 1		flag
Command	rF1	9072	W	Reset fan 1 running time	WORD		0 .. 1		flag
Command	rF2	9073	W	Reset fan 2 running time	WORD		0 .. 1		flag
Command	rF3	9074	W	Reset fan 3 running time	WORD		0 .. 1		flag
Command	rF4	9075	W	Reset fan 4 running time	WORD		0 .. 1		flag
Command	rSH	9076	W	Low overheating reset	WORD		0 .. 1		flag

FOLDER	LABEL	ADDRESS	R/W	DESCRIPTION	DATA TYPE	CML	RANGE	EXP	U.M.
AI	dC1	9219	R	Compressor 1 operating days	WORD		0 .. 65535		num
AI	dC2	9220	R	Compressor 2 operating days	WORD		0 .. 65535		num
AI	dC3	9221	R	Compressor 3 operating days	WORD		0 .. 65535		num
AI	dC4	9222	R	Compressor 4 operating days	WORD		0 .. 65535		num
AI	hC1	9223	R	Compressor 1 operating hours	WORD		0 .. 65535		h
AI	hC2	9224	R	Compressor 2 operating hours	WORD		0 .. 65535		h
AI	hC3	9225	R	Compressor 3 operating hours	WORD		0 .. 65535		h
AI	hC4	9226	R	Compressor 4 operating hours	WORD		0 .. 65535		h
AI	dF1	9227	R	Fan 1 operating days	WORD		0 .. 65535		num
AI	dF2	9228	R	Fan 2 operating days	WORD		0 .. 65535		num
AI	dF3	9229	R	Fan 3 operating days	WORD		0 .. 65535		num
AI	dF4	9230	R	Fan 4 operating days	WORD		0 .. 65535		num
AI	hF1	9231	R	Fan 1 operating hours	WORD		0 .. 65535		h
AI	hF2	9232	R	Fan 2 operating hours	WORD		0 .. 65535		h
AI	hF3	9233	R	Fan 3 operating hours	WORD		0 .. 65535		h
AI	hF4	9234	R	Fan 4 operating hours	WORD		0 .. 65535		h
AI	PC1	9031	R	Power generated by compressor 1	WORD		0 .. 100		%
AI	PC2	9032	R	Power generated by compressor 2	WORD		0 .. 100		%
AI	PC3	9033	R	Power generated by compressor 3	WORD		0 .. 100		%
AI	PC4	9034	R	Power generated by compressor 4	WORD		0 .. 100		%

CHAPTER 12

Alarms

Label	Description	Reset	Action	Solution
Er01	Suction pressure probe error (see para. CPE and CPI)	AUTO	 inhibited	<ul style="list-style-type: none"> •Check wiring •Replace the probe in compliance with the input settings •Wait for the read temperature value to be restored
Er02	Discharge pressure probe error	AUTO	Floating condensation inhibited  inhibited  100% ON	
Er03	External temperature probe error	AUTO	Floating condensation inhibited	
Er04	Liquid return temperature probe error	AUTO	Sub-cooling inhibited	
Er05	Discharge temperature probe error	AUTO	 inhibited	
Er06	Suction Temperature alarm	AUTO	Overheating inhibited	
Er07	DGS high temperature lock alarm	AUTO	 inhibited (Ct1 = 5)	Wait for the discharge temperature to return to within the nominal values
Er08	General Regulator Probe alarm	AUTO	General regulator inhibited	See Solution for alarm Er01
Er10	Compressor 1 thermal switch alarm	AUTO	 ₁ inhibited	Check the relative digital input
Er11	Compressor 2 thermal switch alarm	AUTO	 ₂ inhibited	
Er12	Compressor 3 thermal switch alarm	AUTO	 ₃ inhibited	
Er13	Compressor 4 thermal switch alarm	AUTO	 ₄ inhibited	
Er20	Fan 1 thermal switch alarm	AUTO	 ₁ inhibited	
Er21	Fan 2 thermal switch alarm	AUTO	 ₂ inhibited	
Er22	Fan 3 thermal switch alarm	AUTO	 ₃ inhibited	
Er23	Fan 4 thermal switch alarm	AUTO	 ₄ inhibited	
Er24	Fan Inverter alarm		 inhibited	Check the relative digital input
Er30	Maximum pressure switch alarm	AUTO	 inhibited  100% ON	
Er31	Minimum pressure switch alarm	AUTO	  inhibited	Wait for the suction pressure to return to within the nominal values
Er40	Maximum Discharge Pressure alarm	AUTO + dHA + dtt	Display only	---
Er41	Minimum Discharge Pressure alarm	AUTO + dLA + dtt		---
Er42	High suction pressure alarm	AUTO + SHA + dtt		---
Er43	Low suction pressure alarm	AUTO + SLA + dtt		---
Er44	Low overheating alarm	AUTO		 inhibited (oAM = 1)
Er45	High overheating alarm	AUTO	Display only	---

Er46	Low overheating alarm	MAN	See Er44 par. PenS, PeiS	---
Er47	Gas alarm	AUTO	---	Check refrigerant level
Er50	Expansion device alarm	AUTO	---	Check Expansion device connections

CHAPTER 13

Updating the device

13.1. DIRECT CONNECTION WITH DEVICE MANAGER

Use the **DMI** to connect the **EWCM 400D PRO A-STD** controller to the PC/serial port for quick parameter programming.

DMI connection

To connect the **DMI** to the **EWCM 400D PRO A-STD**, use the **YELLOW (YW)** cable.

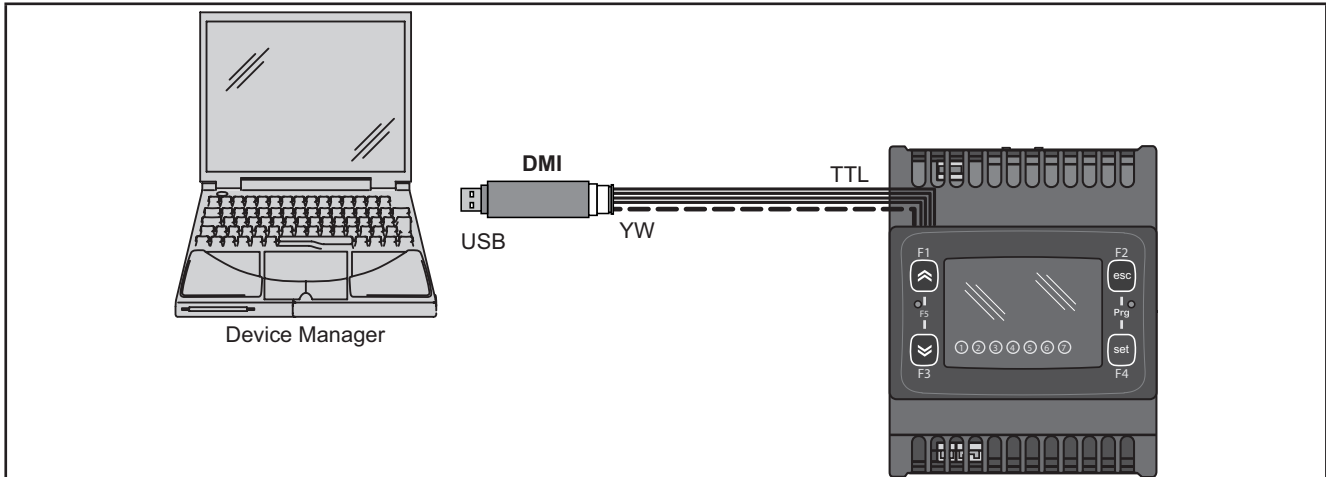

Fig. 45. Connection between **DMI / UNICARD** and **EWCM 400D PRO A-STD**

NOTE: in this "Direct" mode, **EWCM 400D PRO A-STD** must not be connected to ground. When connecting to ground for both the PC and the **EWCM 400D PRO A-STD** there could be a ring ground condition that makes both the PC and the **EWCM 400D PRO A-STD** unusable.

NOTICE

INOPERABLE DEVICE

Disconnect all ground connections on the device before connecting to a PC.

Failure to follow these instructions can result in equipment damage.

13.2. CONNECTING TO UNICARD / MFK

To connect the **MFK** to the **DMI**, use the **BLUE** cable.

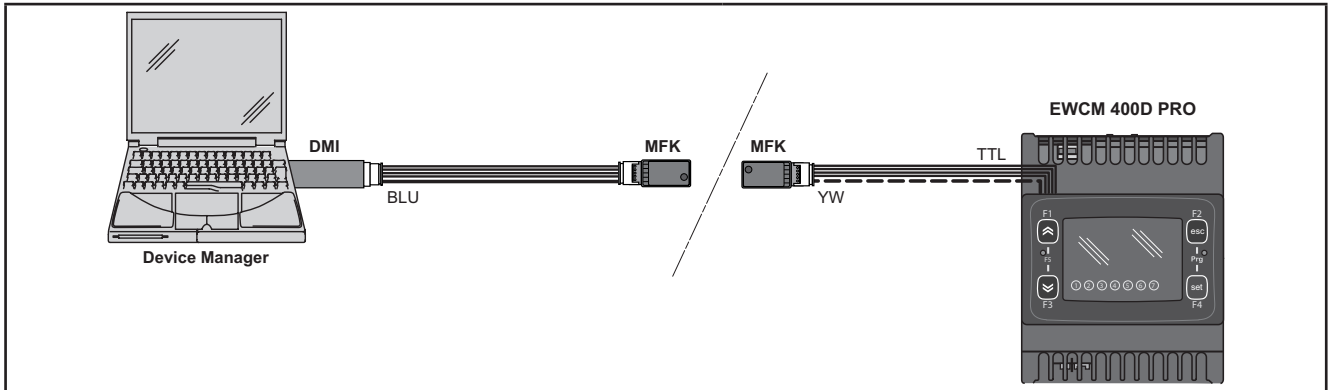

Fig. 46. Connection between the MFK/UNICARD and DMI + Device Manager

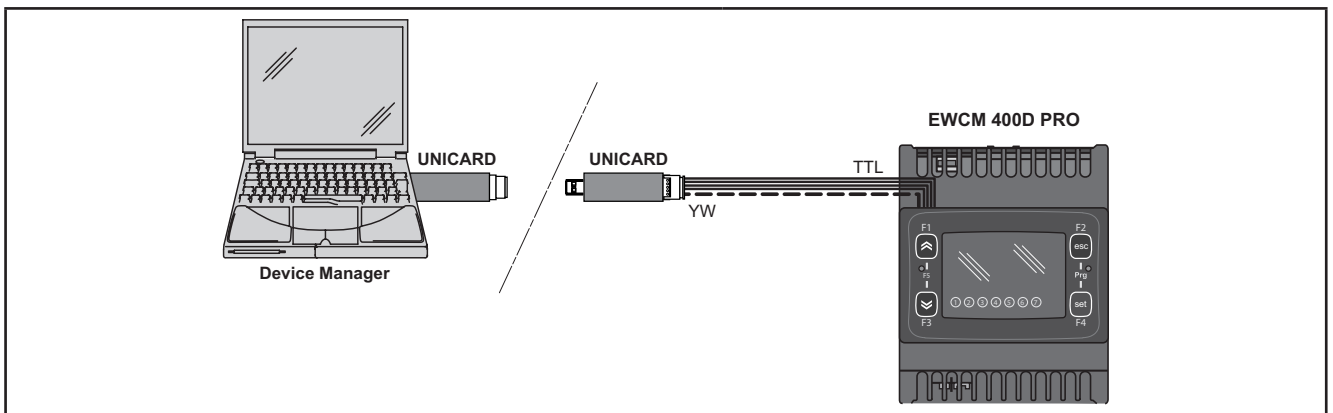

Fig. 47. Connection between UNICARD and Device Manager + EWCM 400D PRO A-STD

Device Manager → MFK / UNICARD	Device Manager ← MFK / UNICARD
Parameters	Parameters
Fw	-

⚠ WARNING

UNINTENDED EQUIPMENT OPERATION

- Connect the programming cable firstly to the PC and then to the controller programming port.
- Disconnect the programming cable from the controller before disconnecting from the PC.

Failure to follow these instructions can result in death, serious injury, or equipment damage.

13.3. FIRMWARE UPDATING

To update the firmware on the **EWCM 400D PRO A-STD** controller, first update the UNICARD key/MFK using **Device Manager**.

When connecting to the **EWCM 400D PRO A-STD** controller having switched off the updated key, the firmware download will run automatically when the instrument is switched on. The key LED flashes while the operation is in progress.

When completed, the key LED may assume one of the following statuses:

- **ON**: If the operation was successful.
- **OFF**: If the operation was not successful (in this case repeat the procedure or update the key contents).

NOTE: When connecting a key with the same contents as the controller, no firmware will be downloaded and the key LED will stay off.

CHAPTER 14

Monitoring

The serial TTL can be used to configure the device, parameters, statuses, and variables via the Modbus protocol.

14.1. CONFIGURATION WITH MODBUS RTU

Modbus is a client/server protocol for communication between devices connected in a network.

Modbus devices communicate using a master-slave technique in which only one device (master) can send messages. The other devices in the network (slave) respond, returning the data requested by the master or executing the action contained in the message received. A slave is a device connected to a network that processes information and sends the results to the master using the Modbus protocol.

The master device can send messages to individual slaves or to the entire network (broadcast) whilst slaves can only respond to individual messages sent by the master.

NOTE: The Modbus standard used by **Eliwell** employs the RTU code for data transmission.

14.1.1. Data format (RTU)

The coding model used defines the structure of messages transmitted on the network and the way in which this information is deciphered. The coding type is usually chosen according to specific parameters (baud rate, parity, etc.)*** and some devices only support certain coding models. However, the model used must be the same as used for all devices connected to a Modbus network.

The protocol used adopts the RTU binary method with bytes configured as follows:

8 bits for data, even (odd) parity bit, 1 stop bit (non-configurable).

***configured with parameters **CF30**, **CF31**.

Parameter setting allows full configuration of the device.

Changes can be made via:

- the user interface of the instrument.
- **MFK**.
- SKP 10 remote display
- Sending data via Modbus protocol directly to an individual controller or broadcasting it using the address 0 (broadcast).

For the connection diagram using Modbus see **Fig. 12 page 24**.

Device / Bus Adapter connection	TTL 5-way connector cable (30 cm) (additional lengths/sizes available)
Bus Adapter	BA150
Bus Adapter / Interface connection	RS-485 cable shielded and twisted (e.g.: Belden cable model 8762)

14.1.2. Modbus commands available and data areas

The following commands are implemented:

Modbus command	Command description
3	Reading more than one log on the Client side
6	Writing only one log on the Client side
16	Writing more than one log on the Client side
43	Read device ID
	DESCRIPTION Manufacturer ID Model ID Version ID

NOTE: For the variables see [11.1.4. Client Table page 89](#).

14.2. DEVICE ADDRESS

The address of a device (Device Number) in a Modbus message is defined in parameter **CF30** (see [11.1.1. BIOS / visibility parameters table page 71](#)).

The address 0 is used for broadcast messages that all slaves recognize.

NOTE: The slaves do not respond to broadcast messages.

14.2.1. List of parameter addresses

The list of addresses is given in [CHAPTER 11 Parameters \(PAR\) page 69](#), under "Parameters/Visibility Table / ADDRESS column (parameter addresses) and VIS PAR ADDRESS (addresses visibility parameters).

14.2.2. List of variable addresses / states

The list of addresses is given in [CHAPTER 11 Parameters \(PAR\) page 69](#), Client Table section, ADDRESS column.

Eliwell Controls s.r.l.

Via dell'Industria, 15 • Z.I. Paludi

32016 Alpago (BL) ITALY

Tel. +39 0437 166 0000

www.eliwell.com

Customer Technical Support

Tel. +39 0437 986 300

E techsuppeliwell@se.com

Sales office

Tel. +39 0437 986 100 (Italy)

Tel. +39 0437 986 200 (other countries)

E saleseliwell@se.com